

Switched-mode and uninterruptible power supplies, and electronic fuses

Catalogue 2017/2018

Let's connect.

Power supply



Weidmüller 

Dear Customers,

The PDF versions of our catalogues offer practical additional functions, helping you to find your way around our product range and simplifying the ordering process.

In addition to the catalogue, the PDF also contains:

- Internal page links
- Links to the online catalogue

Try it out for yourself. Click the order number to obtain more detailed information and close-up images via your web browser. The links in the PDF file also enable you to go directly to the next desired catalogue page.

Further Weidmüller product catalogues can be accessed by clicking the following:



Switch-Mode and Uninterruptible Power Supplies, Electronic Fuses

Catalogue 4.3

Switch-Mode and Uninterruptible Power Supplies, Electronic Fuses

Switch-mode power supplies

Uninterruptible power supplies (UPS)

Load monitoring for 24 V DC circuits

Electrical cabinet socket outlet

Contents

A

B

C

D

Appendix

Service and support

Glossary/Technical appendix

Index

Index Type / Index Order No.
Addresses worldwide

V

W

X

Power supplies – Overview

connectPower 1ph PROeco



- Single-phase switched-mode power supply modules
- Slim design
- Large temperature range from -25 °C to 70 °C
- Three-coloured LED indicators for simple error detection
- Advanced visual warning at 90 % rated output current
- International approvals

connectPower 3ph PROeco



- 3-phase switched-mode power supply modules
- Slim design
- Large temperature range from -25 °C to 70 °C
- Three-coloured LED indicators for simple error detection
- Advanced visual warning at 90 % rated output current
- International approvals

connectPower diode modules



- Diode module for 100 % decoupling of switched-mode power supply modules
- Optimum doubling of output power
- Redundancy operation
- Up to 40 A output current can be set
- International approvals

connectPower 1ph PROmax



- Single-phase switched-mode power supply modules
- Very slim design
- High degree of efficiency
- Power category 70...1,000 W
- Up to five devices can be connected in parallel without a diode module
- International approvals

connectPower 3ph PROmax



- 3-phase switched-mode power supply modules
- Very slim design
- High degree of efficiency
- Power category 120...1,000 W
- Up to five devices can be connected in parallel without a diode module
- International approvals

connectPower PRO-M Extension modules



- Capacity module for increasing the peak current
- Diode modules for redundant construction
- Relay module for monitoring the output voltage

connectPower PRO-M Application solutions



- Wide-range input
85...264 V AC
80...430 V DC
- Alarm relay
- Metal snap-on foot
- International approvals

connectPower 1ph PROtop



- Single-phase switched-mode power supplies
- High MTBF values
- Cl. I Div. 2 + ATEX
- Performance class: 70 to 600 W
- Output: 12, 24, 36 and 48 V DC

connectPower 3ph PROtop



- Multi-phase switched-mode power supplies
- 85...132 / 187...550 V AC
- UL approval
- Performance class: 180 to 600 W

connectPower PRO-E



- Wall mounting
- Flat design
- Metal housing
- Performance classes from 25 W to 350 W
- Universal input and output voltages

connectPower 1ph INSTAPOW



- Single-phase switched-mode power supply modules for the distribution board
- Compact form
- Power category 24 and 48 W
- Universal input and output voltage 5...48 V
- International approvals

connectPower DC/DC converters



- Compact form
- Metal housing
- International approvals
- High degree of efficiency

connectPower UPS control unit



- Two 24 V models in 10 A/20 A and 40 A
- Temperature-compensated charging feature, for a long battery life
- Integrated battery diagnostics including continuous availability test
- Status relay and additional transistor outputs for remote monitoring
- Convenient LED displays for easy error analysis

connectPower battery module



- Maintenance-free, lead-acid batteries from 1.3 Ah to 17 Ah
- Integrated temperature sensor for optimal battery charging
- Integrated fuse for reliable activation
- Support capacity up to 40 A / 30 min or 10 A / 90 min
- Robust metal housing for wall mounting

connectPower buffer module



- Maintenance-free UPS on a capacitor basis, with a capacity to support 20 A / 200 ms
- Parallel switching to increase the output current or support time
- Status notification via LED and relay contact

maxGUARD



- Electronic load monitoring
- Optical message display and potential-free (floating) contact
- Reset input
- Compact construction











Electrical cabinet socket outlet



- Simple installation in electrical cabinet
- TS 35 module can be rail mounted
- VDE mark of conformity
- Two-pole with earthing contact

Find the perfect product to meet your requirement

Our extensive portfolio of power supplies at a glance

Page	Series / family	Input side			Output side			Additional functions				Recommendation for application						Order No.							
		Description	Phases	AC input voltage [V]	DC input voltage [V]	Rated voltage [V]	Rated current [A]	Power rating [W]	Derating at [°C]	Load reserve [60 s]	Status relay	Side-by-side connectability	Temperature range [°C]	Efficiency [%]	MTBF time [Mh]	Surge category	Approvals		Field cabinets	Small and series machine construction	Machine construction and plant manufacture	Simple process applications	Process industry	Energy technology	Power distribution
PROeco A.4	PRO ECO 72 W 24 V 3 A	1	85-264	80-370	24	3	72	> 55		NO	●	-25 to +70	87	> 0,5	II	  	●	●	●	●	●	●	●	●	1469470000
	PRO ECO 120 W 24 V 5 A	1	85-264	80-370	24	5	120			NO	●		87				1469480000								
	PRO ECO 240 W 24 V 10 A	1	85-264	80-370	24	10	240			NO	●		90				1469490000								
	PRO ECO 480 W 24 V 20 A	1	85-264	80-370	24	20	480			NO	●		91				1469510000								
	PRO ECO 960 W 24 V 40 A	1	85-264	80-370	24	40	960			NO	●		93				1469520000								
	PRO ECO3 120 W 24 V 5 A	3	340-575	450-870	24	5	120			NO	●		87				1469530000								
	PRO ECO3 240 W 24 V 10 A	3	340-575	450-870	24	10	240			NO	●		88				1469540000								
	PRO ECO3 480 W 24 V 20 A	3	340-575	450-870	24	20	480			NO	●		89				1469550000								
	PRO ECO3 960 W 24 V 40 A	3	340-575	450-870	24	40	960			NO	●		90				1469560000								
	PRO ECO 72 W 12 V 6 A	1	85-264	80-370	12	6	72			NO	●		90				1469570000								
	PRO ECO 120 W 12 V 10 A	1	85-264	80-370	12	10	120			NO	●		90				1469580000								
	PRO ECO 240 W 48 V 5 A	1	85-264	80-370	48	5	240			NO	●		90				1469590000								
PRO ECO 480 W 48 V 10 A	1	85-264	80-370	48	10	480	NO	●	90	1469610000															
PROmax A.14	PRO MAX 72 W 24 V 3 A	1	85-277	80-370	24	3	72	> 60	120 % 300 % @ 1 s	CO	●	-25 to +70	90	> 0,5	III	      	●	●	●	●	●	●	●	1478100000	
	PRO MAX 120 W 24 V 5 A	1	85-277	80-370	24	5	120			CO	●		90				1478110000								
	PRO MAX 180 W 24 V 7,5 A	1	85-277	80-370	24	7,5	180			CO	●		91				1478120000								
	PRO MAX 240 W 24 V 10 A	1	85-277	80-370	24	10	240			CO	●		91				1478130000								
	PRO MAX 480 W 24 V 20 A	1	85-277	80-370	24	20	480			CO	●		91,5				1478140000								
	PRO MAX 960 W 24 V 40 A	1	85-277	80-370	24	40	960			CO	●		92,5				1478150000								
	PRO MAX3 120 W 24 V 5 A	3	3 x 320-3 x 575	450-800	24	5	120			CO	●		90				1478170000								
	PRO MAX3 240 W 24 V 10 A	3	3 x 320-3 x 575	450-800	24	10	240			CO	●		91				1478180000								
	PRO MAX3 480 W 24 V 20 A	3	3 x 320-3 x 575	450-800	24	20	480			CO	●		91,5				1478190000								
	PRO MAX3 960 W 24 V 40 A	3	3 x 320-3 x 575	450-800	24	40	960			CO	●		92,5				1478200000								
	PRO MAX 70 W 5 V 14 A	1	85-277	80-370	5	14	70			CO	●		86				1478210000								
	PRO MAX 72 W 12 V 6 A	1	85-277	80-370	12	6	72			CO	●		89				1478220000								
	PRO MAX 120 W 12 V 10 A	1	85-277	80-370	12	10	120			CO	●		89				1478230000								
	PRO MAX 240 W 48 V 5 A	1	85-277	80-370	48	5	240			CO	●		91				1478240000								
	PRO MAX 480 W 48 V 10 A	1	85-277	80-370	48	10	480			CO	●		91,5				1478250000								
	PRO MAX 960 W 48 V 20 A	1	85-277	80-370	48	20	960			CO	●		92,5				1478270000								

NO = NO contact
 CO = CO contact
 Start-up @ -40°C = In the range of -40 to -25°C the device starts, but some technical parameter may differ (i. e., ripple-voltage).

Page	Series / family	Input side			Output side			Additional functions				Recommendation for application						Order No.										
		Description	Phases	AC input voltage [V]	DC input voltage [V]	Rated voltage [V]	Rated current [A]	Power rating [V]	Derating at [°C]	Load reserve [60 s]	Status relay	Side-by-side connectability	Temperature range [°C]	Efficiency [%]	MTBF time [Mh]	Surge category	Approvals		Field cabinets	Small and series machine construction	Machine construction and plant manufacture	Simple process applications	Process industry	Energy technology	Power distribution	Marine engineering		
PROtop A.30	PRO TOP1 72W 24V 3A	1	85-277	80-410	24	3	72	> 60	130 % permanently ≤ 40 °C	NO		-25 to +75	90	> 1	III	CE										2466850000		
	PRO TOP1 120W 24V 5A	1	85-277	80-410	24	5	120			NO			91														2466870000	
	PRO TOP1 240W 24V 10A	1	85-277	80-410	24	10	240			NO			92,5			TV											2466880000	
	PRO TOP1 480W 24V 20A	1	85-277	80-410	24	20	480			NO			93,5														2466890000	
	PRO TOP1 960W 24V 40A	1	85-277	80-410	24	40	960			NO			94,5														2466900000	
	PRO TOP1 120W 12V 10A	1	85-277	80-410	12	10	120			NO			91														2466910000	
	PRO TOP1 480W 48V 10A	1	85-277	80-410	48	10	480			NO			93,5														2467030000	
	PRO TOP1 960W 48V 20A	1	85-277	80-410	48	20	960			NO			94,5														2466920000	
	PRO TOP3 120W 24V 5A	2/3	3 x 320-3 x 575/ 2 x 360-2 x 575	450-800 (max. 500 nach UL508)	24	5	120			NO			87,1			Approvals in preparation											2467060000	
	PRO TOP3 240W 24V 10A	2/3	3 x 320-3 x 575/ 2 x 360-2 x 575	450-800 (max. 500 nach UL508)	24	10	240			NO			93,5															2467080000
	PRO TOP3 480W 24V 20A	2/3	3 x 320-3 x 575/ 2 x 360-2 x 575	450-800 (max. 500 nach UL508)	24	20	480			NO		Start-up @ -40 °C	94															2467100000
	PRO TOP3 960W 24V 40A	2/3	3 x 320-3 x 575/ 2 x 360-2 x 575	450-800 (max. 500 nach UL508)	24	40	960			NO			95,4															2467120000
	PRO TOP3 480W 48V 10A	2/3	3 x 320-3 x 575/ 2 x 360-2 x 575	450-800 (max. 500 nach UL508)	48	10	480			NO			94															2467150000
	PRO TOP3 960W 48V 20A	2/3	3 x 320-3 x 575/ 2 x 360-2 x 575	450-800 (max. 500 nach UL508)	48	20	960			NO			95,4															2467170000

Series / family		Input side		Output side				Additional functions					Recommendation for application				Order No.			
Page	Description	AC input voltage [V]	DC input voltage [V]	Rated voltage [V]	einstellbarer Bereich [V]	Rated current [A]	Power rating [V]	Status relay	Parallel connection option	Side-by-side connectability	Temperature range [°C]	MTBF time [Mh]	Approvals	Field cabinets	Energy technology	Marine engineering				
DC/DC A.64	PRO DCDC 120W 24V 5A	18-31,2	24	22,5-29,5	5	120	≤ 5	●	●	●	-25 to +70	> 1	III	UL US GL Ex CE EAC C11Div2	●	●	●	●	●	2001800000
	PRO DCDC 240W 24V 10A	18-31,2	24	22,5-29,5	10	240	●	●	●	●	-25 to +70	> 1	III	UL US GL Ex CE EAC C11Div2	●	●	●	●	●	2001810000
	PRO DCDC 480W 24V 20A	18-31,2	24	22,5-29,5	20	480	●	●	●	●	-25 to +70	> 1	III	UL US GL Ex CE EAC C11Div2	●	●	●	●	●	2001820000
USV B.4	CP DC BUFFER 24 V 20 A	22,5-30	24		20	480	●	●	●	●	0 to +40			UL US GL Ex CE EAC C11Div2						1251220000
	CP DC UPS 24 V 20 A/10 A	20-30	U _{in} -0,3		20/10	480/240	●	●	●	●	0 to +40			UL US GL Ex CE EAC C11Div2						1370050010
	CP DC UPS 24 V 40 A	20-30	U _{in} -0,3		40	960	●	●	●	●	0 to +40			UL US GL Ex CE EAC C11Div2						1370040010
	CP A BATTERY 24 V DC 1,3 Ah		24		10 A / 11,3 min	1,3 Ah	≤ 2	●	●	●	0 to +40			UL US GL Ex CE EAC C11Div2						1406930000
	CP A BATTERY 24 V DC 3,4 Ah		24		10 A / 11,3 min	3,4 Ah	≤ 2	●	●	●	0 to +40			UL US GL Ex CE EAC C11Div2						1251070000
	CP A BATTERY 24 V DC 7,2 Ah		24		10 A / 26,5 min	7,2 Ah	≤ 2	●	●	●	0 to +40			UL US GL Ex CE EAC C11Div2						1251080000
	CP A BATTERY 24 V DC 12 Ah		24		10 A / 51 min	12 Ah	≤ 2	●	●	●	0 to +40			UL US GL Ex CE EAC C11Div2						1251090000
CP A BATTERY 24 V DC 17 Ah		24		10 A / 81 min	17 Ah	≤ 2	●	●	●	0 to +40			UL US GL Ex CE EAC C11Div2						1251110000	
Diode module A.12	PRO DM 10	0-60	24	0-60	20	480	●	●	●	●	-40 to +70	> 750	III	CE	●	●	●	●	●	2486070000
	PRO DM 20	0-60	24	0-60	40	960	●	●	●	●	-40 to +70	> 750	III	CE	●	●	●	●	●	2486080000
	CP M DM 20 (Diodenmodul)	18-30	U _{in} -0,7		20		●	●	●	●	-25 to +70			UL US GL Ex CE EAC C11Div2						1222210000
	CP M DM 40 (Diodenmodul)	18-30	U _{in} -0,7		40		●	●	●	●	-25 to +70			UL US GL Ex CE EAC C11Div2						1222220000
A.25	CP M CAP (Kapazitätsmodul)	18-30	U _{in}		40 A/1 ms		●	●	●	●				UL US GL Ex CE EAC C11Div2						1222240000
INSTAPOWVER A.58	CP SNT 25 W 5 V 5 A	85-264	110-370	5	4-8	5	25	≤ 3	●	●	-10 to +70			UL US GL Ex CE EAC C11Div2						8754960000
	CP SNT 48 W 12 V 4 A	85-264	110-370	12	9-15	4	48	≤ 3	●	●	-10 to +70			UL US GL Ex CE EAC C11Div2						8754970000
	CP SNT 48 W 24 V 2 A	85-264	110-370	24	15-28	2	48	≤ 3	●	●	-10 to +70			UL US GL Ex CE EAC C11Div2						8739140000
	CP SNT 48 W 48 V 1A	85-264	110-370	48	46-55	1	48	≤ 3	●	●	-10 to +70			UL US GL Ex CE EAC C11Div2						8879230000

Switch-mode power supplies

Switch-mode power supplies	Overview	A.2
	connectPower PROeco	A.4
	connectPower PROmax	A.14
	connectPower PROtop	A.30
	connectPower PRO-E	A.42
	connectPower INSTAPOWER	A.58
	connectPower DC/DC converter	A.64

г. Минск www.fotorele.net www.tiristor.by email minsk17@tut.by тел. +375447584780

Switch-mode power supplies

The switch-mode power supplies feature a high degree of efficiency, compact dimensions and minimal heat generation.

They are an excellent, reliable solution for providing power in all automation applications – safely providing 24 V DC voltage.

The different product series are optimised for the automation industry: they feature Ex approvals for the processing industry, a flat shape perfect for distribution tasks within buildings, or provide decentralised control voltages.

All-purpose usage: with a wide range of AC/DC inputs, single-, double- or three-phase versions, and a wide temperature range. Additional performance increases are possible using simple parallel circuitry. Weidmüller

switch-mode power supplies can be depended upon for all applications because of their high efficiency and their resistance to both short circuits and overloads.

Weidmüller offers a system of one- and three-phase switch-mode power supplies especially for the PROmax family. These can be expanded with additional modules to create whole system solutions. The appropriate system can be assembled for any type of application: with redundancy circuits containing decoupled outputs, monitoring of the output voltage or triggering of circuit breakers.



AC/DC**International use**

A wide-range input (both DC as well as AC voltages can be used; no switching required) and extensive approvals (UL/CSA and GL (EMC 1 – bridge)).

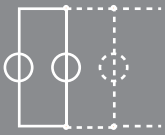
**Parallel connection**

Module power can be increased by connecting upto five power supplies in parallel without diode module.

**Narrow**

Space-saving configuration in the switching cabinet through very narrow housing construction and side-by-side connectability.

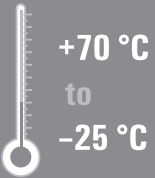
**Robust**

Wide temperature range from -25 °C ... +70 °C.

**Wide choice**

The right power supply for every application: 1-phase 3 A, 5 A, 7.5 A, 10 A, 20 A, 40 A and 3-phase 5 A, 10 A, 20 A, 40 A.

connectPower**connectPower PROeco****connectPower PROmax****connectPower PROtop****connectPower PRO-E****connectPower INSTAPOWERR****connectPower DC/DC converters**

PROeco power supplies with basic functionality and a high level of reliability

- Single- and three-phase switched-mode power supply units
- Slim design
- Large temperature range from -25 °C to 70 °C
- The output voltage can be precisely adjusted via the potentiometer on the front
- Remote monitoring via integrated status relay
- Three-coloured LED indicators for simple error detection
- Advanced visual warning at 90 % rated output current
- International approvals



Derating curves

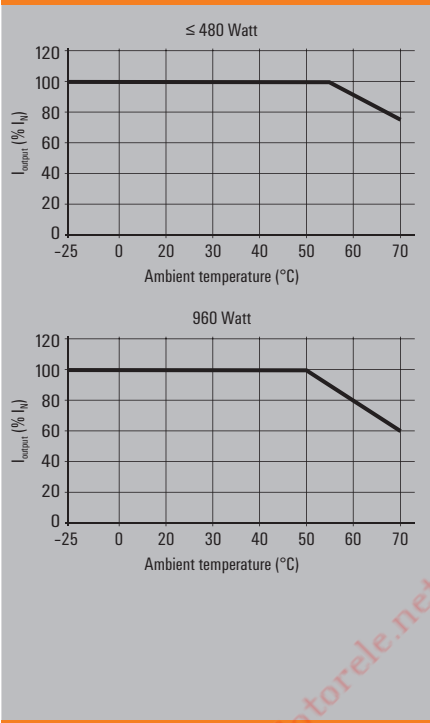

Technical data

General technical data	
Ambient temp. operating / storage temperature	-25 °C...+70 °C / -40 °C...+85 °C
Max. perm. air humidity (operation)	5 %...95 % RH
Degree of protection	IP 20
Class of protection	I, with PE connection
Pollution degree	2
Insulation voltage input/output	3 kV E/A / 2 kV E/earth / 0.5 kV A/earth
MTBF	> 500.000 h (25 °C, IEC 61709)
Parallel connection option	yes, max. 5 without diode module
Housing version	metal, corrosion resistant
Mounting position, installation notice	horizontal on mounting rail TS35, 50 mm spacing top and bottom for free air circulation
Short-circuit protection	Yes, automatic restart
Overload protection	Yes, IU characteristic curve
Overtemperature protection	Yes, automatic restart
EMC / shock / vibration	
Noise emission acc. to EN5022	Class B
Noise immunity tests acc. to	EN61000-4-2 (ESD), EN61000-4-3 and EN61000-4-8 (Fields), EN61000-4-4 (Burst), EN61000-4-5 (Surge), EN61000-4-6 (conducted), EN61000-4-11 (Dips)
Limiting of mains voltage harmonic currents	Acc. to EN61000-3-2
Resistance against vibration and shock	1 g acc. to EN50178, shock: 15 g in all directions
Electrical safety (applied standards)	
Electrical equipment of machines	Acc. to EN60204
Safety transformers for switched-mode power units	Acc. to EN61558-2-17
Machinery with electronic equipment	Acc. to EN50178 / VDE0160
Safety extra-low voltage	SELV acc. to EN60950-1, PELV acc. to EN60204-1
Protective separation / protection against electrical shock	VDE0100-410 / acc. to DIN57100-410
Protection against dangerous shock currents	Acc. to VDE0106-101

connectPower PROeco

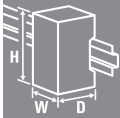

PRO ECO 72W 24V 3A



Similar to illustration

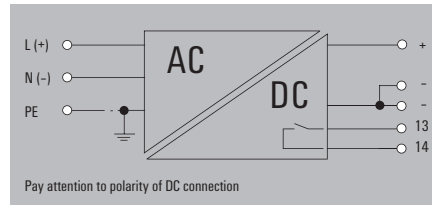

PRO ECO 120W 24V 5A



Similar to illustration

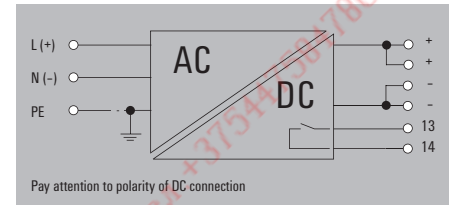

Technical data

Input
Rated input voltage
Input voltage range AC
Frequency range AC
DC input voltage range
AC current consumption
DC current consumption
Input fuse (internal) / Inrush current
Recommended back-up fuse

Output
Rated output voltage
Output voltage
Ramp-up time / Residual ripple, breaking spikes
Rated (nominal) output current @ U_{Nom}
Continuous output current @ U_{Rated}
Capacitive load
Protection against inverse voltage

Signalling
Indication

Floating contact / Contact load
Relay on/off

General data
Degree of efficiency
Power loss idling / nominal load / Power loss, nominal load
Earth leakage current, max.
Power factor (approx.)
AC failure bridging time @ I_{Nom}
Parallel connection option
Depth x width x height / Net weight

Approvals
Approvals

Connection data	
Connection system	
Number of terminals	
Wire cross-section, rigid min/max	mm ²
Wire cross-section, flexible min/max	mm ²
Wire cross-section, AWG/kcmil min/max	
Tightening torque range	

Note

Ordering data

Type	Qty.	Order No.
PRO ECO 72W 24V 3A	1	1469470000

Note

100...240 V AC (wide-range input)
85...264 V AC (Derating @ 100 V AC)
47...63 Hz
80...370 V DC (Derating @ 120 V DC)
0,55 A @ 230 V AC / 1,04 A @ 110 V AC
0,22 A @ 370 V DC / 0,68 A @ 120 V DC
Yes / max. 40 A
2 A / DI, safety fuse
6 A, Char. B, circuit breaker
2...4 A, Char. C, circuit breaker

24 V DC \pm 1 %
22...28 V (adjustable via potentiometer)
\leq 100 ms / $<$ 50 mV _{SS} @ 24 V DC, I_N
3 A at 55 °C
3 A @ 55 °C, 2,25 A @ 70 °C
unrestricted
Yes

LED green ($U_{output} > 21.6$ V DC), LED yellow ($I_{output} > 90\% I_{Rated}$ typ.), LED red (overload, overtemperature, short-circuit, $U_{output} < 20.4$ V DC)
--

Yes / max. 30 V DC / 1 A
Output voltage >21.6 V DC / <20.4 V DC, Overload

87 %
4 W / 9.5 W
3.5 mA
> 0.5 @ 230 V AC / > 0.53 @ 115 V AC
> 100 ms @ 230 V AC / > 20 ms @ 115 V AC
yes, max. 5
100 / 34 / 125 mm / 576 g

CE; cULus; EAC; TUEV

Input	Output
Screw connection	Screw connection
3 for L/N/PE	5 (+, -, 13, 14)
0.5 / 6	0.5 / 6
0.5 / 2.5	0.5 / 2.5
26 / 12	26 / 12
	0.5 / 0.6

Note

Type	Qty.	Order No.
PRO ECO 72W 24V 3A	1	1469470000

Note
The internal varistor found in a switch-mode power supply does not replace the need for surge protection within a system.

100...240 V AC (wide-range input)
85...264 V AC (Derating @ 100 V AC)
47...63 Hz
80...370 V DC (Derating @ 120 V DC)
1,26 A @ 230 V AC / 2,24 A @ 110 V AC
0,39 A @ 370 V DC / 1,16 A @ 120 V DC
Yes / max. 40 A
4 A / DI, safety fuse
6 A, Char. B, circuit breaker
3...5 A, Char. C, circuit breaker

24 V DC \pm 1 %
22...28 V (adjustable via potentiometer)
\leq 100 ms / $<$ 50 mV _{SS} @ 24 V DC, I_N
5 A at 55 °C
5 A @ 55 °C, 3,75 A @ 70 °C
unrestricted
Yes

LED green ($U_{output} > 21.6$ V DC), LED yellow ($I_{output} > 90\% I_{Rated}$ typ.), LED red (overload, overtemperature, short-circuit, $U_{output} < 20.4$ V DC)
--

Yes / max. 30 V DC / 1 A
Output voltage >21.6 V DC / <20.4 V DC, Overload

87 %
4 W / 15 W
3.5 mA
> 0.5 @ 230 V AC / > 0.53 @ 115 V AC
> 80 ms @ 230 V AC / > 20 ms @ 115 V AC
yes, max. 5
100 / 40 / 125 mm / 675 g

CE; cULus; EAC; TUEV

Input	Output
Screw connection	Screw connection
3 for L/N/PE	6 (+, -, 13, 14)
0.5 / 6	0.5 / 6
0.5 / 2.5	0.5 / 2.5
26 / 12	26 / 12
	0.5 / 0.6

Note

Type	Qty.	Order No.
PRO ECO 120W 24V 5A	1	1469480000

Note
The internal varistor found in a switch-mode power supply does not replace the need for surge protection within a system.

connectPower PROeco

connectPower PROeco



PRO ECO 240W 24V 10A



Similar to illustration

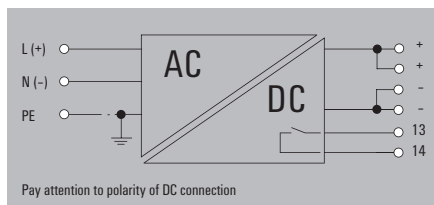

PRO ECO 480W 24V 20A



Similar to illustration

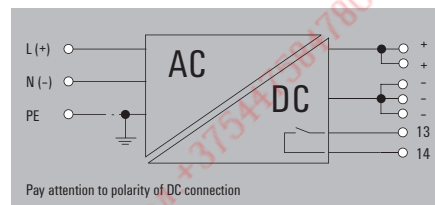

Technical data

Input	
Rated input voltage	100...240 V AC (wide-range input)
Input voltage range AC	85...264 V AC (Derating @ 100 V AC)
Frequency range AC	47...63 Hz
DC input voltage range	80...370 V DC (Derating @ 120 V DC)
AC current consumption	1,23 A @ 230 V AC / 2,47 A @ 110 V AC
DC current consumption	1,18 A @ 370 V DC / 2,4 A @ 120 V DC
Input fuse (internal) / Inrush current	Yes / max. 15 A
Recommended back-up fuse	4 A / DI, safety fuse 10 A, Char. B, circuit breaker 3...4 A, Char. C, circuit breaker

Output	
Rated output voltage	24 V DC ± 1 %
Output voltage	22...28 V (adjustable via potentiometer)
Ramp-up time / Residual ripple, breaking spikes	≤ 100 ms / < 50 mV _{SS} @ 24 V DC, I _N
Rated (nominal) output current @ U _{Nom}	10 A @ 55 °C
Continuous output current @ U _{Rated}	10 A @ 55 °C, 7,5 A @ 70 °C
Capacitive load	unrestricted
Protection against inverse voltage	Yes

Signalling	
Indication	LED green (U _{output} > 21.6 V DC), LED yellow (I _{output} > 90% I _{Rated} typ.), LED red (overload, overtemperature, short-circuit, U _{output} < 20.4 V DC)
Floating contact / Contact load	Yes / max. 30 V DC / 1 A
Relay on/off	Output voltage >21.6 V DC / <20.4 V DC, Overload

General data	
Degree of efficiency	90%
Power loss idling / nominal load / Power loss, nominal load	3 W / 24 W
Earth leakage current, max.	3.5 mA
Power factor (approx.)	> 0.94 @ 230 V AC / > 0.99 @ 115 V AC
AC failure bridging time @ I _{Nom}	> 20 ms @ 230 V AC / > 20 ms @ 115 V AC
Parallel connection option	yes, max. 5
Depth x width x height / Net weight	100 / 60 / 125 mm / 1055 g

Approvals	
Approvals	CE; cULus; EAC; TUEV

Connection data	
Connection system	Screw connection
Number of terminals	3 for L/N/PE
Wire cross-section, rigid min/max	0.5 / 6 mm ²
Wire cross-section, flexible min/max	0.5 / 2.5 mm ²
Wire cross-section, AWG/kcmil min/max	26 / 12
Tightening torque range	0.5 / 0.6

Note	

Ordering data

Type	Qty.	Order No.
PRO ECO 240W 24V 10A	1	1469490000

Note	
The internal varistor found in a switch-mode power supply does not replace the need for surge protection within a system.	

Input	
Rated input voltage	100...240 V AC (wide-range input)
Input voltage range AC	85...264 V AC (Derating @ 100 V AC)
Frequency range AC	47...63 Hz
DC input voltage range	80...370 V DC (Derating @ 120 V DC)
AC current consumption	1,23 A @ 230 V AC / 2,47 A @ 110 V AC
DC current consumption	1,18 A @ 370 V DC / 2,4 A @ 120 V DC
Input fuse (internal) / Inrush current	Yes / max. 15 A
Recommended back-up fuse	4 A / DI, safety fuse 10 A, Char. B, circuit breaker 3...4 A, Char. C, circuit breaker

Output	
Rated output voltage	24 V DC ± 1 %
Output voltage	22...28 V (adjustable via potentiometer)
Ramp-up time / Residual ripple, breaking spikes	≤ 100 ms / < 50 mV _{SS} @ 24 V DC, I _N
Rated (nominal) output current @ U _{Nom}	10 A @ 55 °C
Continuous output current @ U _{Rated}	10 A @ 55 °C, 7,5 A @ 70 °C
Capacitive load	unrestricted
Protection against inverse voltage	Yes

Signalling	
Indication	LED green (U _{output} > 21.6 V DC), LED yellow (I _{output} > 90% I _{Rated} typ.), LED red (overload, overtemperature, short-circuit, U _{output} < 20.4 V DC)
Floating contact / Contact load	Yes / max. 30 V DC / 1 A
Relay on/off	Output voltage >21.6 V DC / <20.4 V DC, Overload

General data	
Degree of efficiency	90%
Power loss idling / nominal load / Power loss, nominal load	3 W / 24 W
Earth leakage current, max.	3.5 mA
Power factor (approx.)	> 0.94 @ 230 V AC / > 0.99 @ 115 V AC
AC failure bridging time @ I _{Nom}	> 20 ms @ 230 V AC / > 20 ms @ 115 V AC
Parallel connection option	yes, max. 5
Depth x width x height / Net weight	100 / 60 / 125 mm / 1055 g

Approvals	
Approvals	CE; cULus; EAC; TUEV

Connection data	
Connection system	Screw connection
Number of terminals	3 for L/N/PE
Wire cross-section, rigid min/max	0.5 / 6 mm ²
Wire cross-section, flexible min/max	0.5 / 2.5 mm ²
Wire cross-section, AWG/kcmil min/max	26 / 12
Tightening torque range	0.5 / 0.6

Note	

Type	Qty.	Order No.
PRO ECO 240W 24V 10A	1	1469490000

Note	
The internal varistor found in a switch-mode power supply does not replace the need for surge protection within a system.	

Input	
Rated input voltage	100...240 V AC (wide-range input)
Input voltage range AC	85...264 V AC (Derating @ 100 V AC)
Frequency range AC	47...63 Hz
DC input voltage range	80...370 V DC (Derating @ 120 V DC)
AC current consumption	2,37 A @ 230 V AC / 5,2 A @ 110 V AC
DC current consumption	1,55 A @ 370 V DC / 4,65 A @ 120 V DC
Input fuse (internal) / Inrush current	Yes / max. 5 A
Recommended back-up fuse	6 A / DI, safety fuse 16 A, Char. B, circuit breaker 6...8 A, Char. C, circuit breaker

Output	
Rated output voltage	24 V DC ± 1 %
Output voltage	22...28 V (adjustable via potentiometer)
Ramp-up time / Residual ripple, breaking spikes	≤ 100 ms / < 50 mV _{SS} @ 24 V DC, I _N
Rated (nominal) output current @ U _{Nom}	20 A @ 55 °C
Continuous output current @ U _{Rated}	20 A @ 55 °C, 15 A @ 70 °C
Capacitive load	unrestricted
Protection against inverse voltage	Yes

Signalling	
Indication	LED green (U _{output} > 21.6 V DC), LED yellow (I _{output} > 90% I _{Rated} typ.), LED red (overload, overtemperature, short-circuit, U _{output} < 20.4 V DC)
Floating contact / Contact load	Yes / max. 30 V DC / 1 A
Relay on/off	Output voltage >21.6 V DC / <20.4 V DC, Overload

General data	
Degree of efficiency	91%
Power loss idling / nominal load / Power loss, nominal load	5 W / 43 W
Earth leakage current, max.	3.5 mA
Power factor (approx.)	> 0.98 @ 230 V AC / > 0.98 @ 115 V AC
AC failure bridging time @ I _{Nom}	> 20 ms @ 230 V AC / > 20 ms @ 115 V AC
Parallel connection option	yes, max. 3
Depth x width x height / Net weight	120 / 100 / 125 mm / 1557 g

Approvals	
Approvals	CE; cULus; EAC; TUEV

Connection data	
Connection system	Screw connection
Number of terminals	3 for L/N/PE
Wire cross-section, rigid min/max	0.5 / 6 mm ²
Wire cross-section, flexible min/max	0.5 / 2.5 mm ²
Wire cross-section, AWG/kcmil min/max	26 / 12
Tightening torque range	0.5 / 0.6

Note	

Type	Qty.	Order No.
PRO ECO 480W 24V 20A	1	1469510000

Note	
The internal varistor found in a switch-mode power supply does not replace the need for surge protection within a system.	

connectPower PROeco

PRO ECO 960W 24V 40A



Similar to illustration

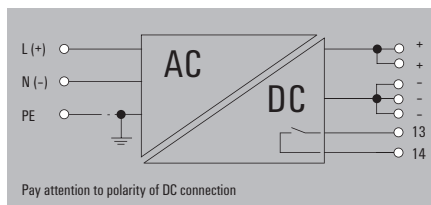

Technical data

Input

Rated input voltage
 Input voltage range AC
 Frequency range AC
 DC input voltage range
 AC current consumption
 DC current consumption
 Input fuse (internal) / Inrush current
 Recommended back-up fuse

100...240 V AC (wide-range input)
 85...264 V AC (Derating @ 100 V AC)
 47...63 Hz
 80...370 V DC (Derating @ 120 V DC)
 4,6 A @ 230 V AC / 9,9 A @ 110 V AC
 2,9 A @ 370 V DC / 9 A @ 120 V DC
 Yes / max. 5 A
 16 A / DI, safety fuse
 20 A, Char. B, circuit breaker
 16 A, Char. C, circuit breaker

Output

Rated output voltage
 Output voltage
 Ramp-up time / Residual ripple, breaking spikes
 Rated (nominal) output current @ U_{Nom}
 Continuous output current @ U_{Rated}
 Capacitive load
 Protection against inverse voltage

24 V DC \pm 1 %
 22...28 V (adjustable via potentiometer)
 ≤ 100 ms / < 50 mV_{SS} @ 24 V DC, I_N
 40 A @ 50 °C
 40 A @ 50 °C, 24 A @ 70 °C
 unrestricted

Signalling

Indication

Yes
 LED green ($U_{output} > 21.6$ V DC), LED yellow ($I_{output} > 90\%$ I_{Rated} typ.), LED red (overload, overtemperature, short-circuit, $U_{output} < 20.4$ V DC)

Floating contact / Contact load
 Relay on/off

Yes / max. 30 V DC / 1 A
 Output voltage > 21.6 V DC / < 20.4 V DC, Overload

General data

Degree of efficiency
 Power loss idling / nominal load / Power loss, nominal load
 Earth leakage current, max.
 Power factor (approx.)
 AC failure bridging time @ I_{Nom}
 Parallel connection option
 Depth x width x height / Net weight

93%
 6 W / 76 W
 3.5 mA
 > 0.98 @ 230 V AC / > 0.98 @ 115 V AC
 > 20 ms @ 230 V AC / > 20 ms @ 115 V AC
 yes, max. 3
 120 / 160 / 125 mm / 3019 g

Approvals

Approvals

CE; cULus; EAC; TUEV

Connection data

Connection system
 Number of terminals
 Wire cross-section, rigid min/max mm²
 Wire cross-section, flexible min/max mm²
 Wire cross-section, AWG/kcmil min/max
 Tightening torque range

Input	Output
Screw connection	Screw connection
3 for L/N/PE	7 (+, -, 13, 14)
0.5 / 6	0.5 / 16
0.5 / 2.5	2.5 / 10
26 / 12	22 / 8
	0.5 / 0.6

Note

Ordering data

Type	Qty.	Order No.
PRO ECO 960W 24V 40A	1	1469520000

Note

The internal varistor found in a switch-mode power supply does not replace the need for surge protection within a system.

connectPower PROeco

connectPower PROeco



PRO ECO 72W 12V 6A



Similar to illustration

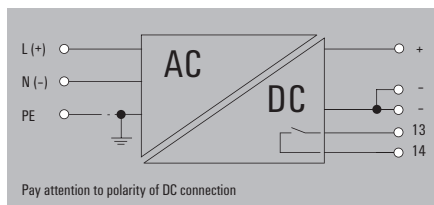

PRO ECO 120W 12V 10A



Similar to illustration

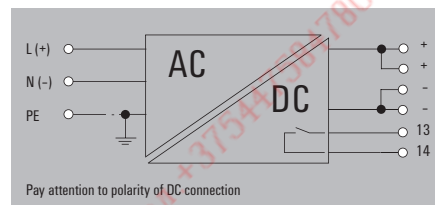

Technical data

Input	
Rated input voltage	100...240 V AC (wide-range input)
Input voltage range AC	85...264 V AC (Derating @ 100 V AC)
Frequency range AC	47...63 Hz
DC input voltage range	80...370 V DC (Derating @ 120 V DC)
AC current consumption	0.6 A @ 230 V AC / 1.1 A @ 115 V AC
DC current consumption	0.25 A @ 370 V DC / 0.7 A @ 120 V DC
Input fuse (internal) / Inrush current	Yes / max. 40 A
Recommended back-up fuse	2 A / DI, safety fuse 6 A, Char. B, circuit breaker 2...4 A, Char. C, circuit breaker

Output	
Rated output voltage	12 V DC ± 1 %
Output voltage	10...16 V (adjustable via potentiometer)
Ramp-up time / Residual ripple, breaking spikes	≤ 100 ms / < 50 mV ss @ 12 V DC, 1 Nenn
Rated (nominal) output current @ U _{Nenn}	6 A @ 55 °C
Continuous output current @ U _{Rated}	6 A @ 55 °C, 4.5 A @ 70 °C
Capacitive load	unrestricted
Protection against inverse voltage	Yes

Signalling	
Indication	LED green (U _{output} > 21.6 V DC), LED yellow (I _{output} > 90% I _{Rated} typ.), LED red (overload, overtemperature, short-circuit, U _{output} < 20.4 V DC)
Floating contact / Contact load	Yes / max. 30 V DC / 1 A
Relay on/off	Output voltage >21.6 V DC / <20.4 V DC, Overload

General data	
Degree of efficiency	85 %
Power loss idling / nominal load / Power loss, nominal load	4 W / 15 W
Earth leakage current, max.	3.5 mA
Power factor (approx.)	> 0.5 @ 230 V AC / > 0.53 @ 115 V AC
AC failure bridging time @ I _{Nenn}	> 100 ms @ 230 V AC / > 20 ms @ 115 V AC
Parallel connection option	yes, max. 5
Depth x width x height / Net weight	100 / 34 / 125 mm / 593 g

Approvals	
Approvals	CE; cULus; EAC; TUEV

Connection data	
Connection system	Screw connection
Number of terminals	3 for L/N/PE
Wire cross-section, rigid min/max	0.5 / 6 mm ²
Wire cross-section, flexible min/max	0.5 / 2.5 mm ²
Wire cross-section, AWG/kcmil min/max	26 / 12
Tightening torque range	0.5 / 0.6

Note	

Ordering data

Type	Qty.	Order No.
PRO ECO 72W 12V 6A	1	1469570000

Note	
The internal varistor found in a switch-mode power supply does not replace the need for surge protection within a system.	

Input	
Rated input voltage	100...240 V AC (wide-range input)
Input voltage range AC	85...264 V AC (Derating @ 100 V AC)
Frequency range AC	47...63 Hz
DC input voltage range	80...370 V DC (Derating @ 120 V DC)
AC current consumption	0.6 A @ 230 V AC / 1.1 A @ 115 V AC
DC current consumption	0.25 A @ 370 V DC / 0.7 A @ 120 V DC
Input fuse (internal) / Inrush current	Yes / max. 40 A
Recommended back-up fuse	2 A / DI, safety fuse 6 A, Char. B, circuit breaker 2...4 A, Char. C, circuit breaker

Output	
Rated output voltage	12 V DC ± 1 %
Output voltage	10...16 V (adjustable via potentiometer)
Ramp-up time / Residual ripple, breaking spikes	≤ 100 ms / < 50 mV ss @ 12 V DC, 1 Nenn
Rated (nominal) output current @ U _{Nenn}	6 A @ 55 °C
Continuous output current @ U _{Rated}	6 A @ 55 °C, 4.5 A @ 70 °C
Capacitive load	unrestricted
Protection against inverse voltage	Yes

Signalling	
Indication	LED green (U _{output} > 21.6 V DC), LED yellow (I _{output} > 90% I _{Rated} typ.), LED red (overload, overtemperature, short-circuit, U _{output} < 20.4 V DC)
Floating contact / Contact load	Yes / max. 30 V DC / 1 A
Relay on/off	Output voltage >21.6 V DC / <20.4 V DC, Overload

General data	
Degree of efficiency	85 %
Power loss idling / nominal load / Power loss, nominal load	4 W / 15 W
Earth leakage current, max.	3.5 mA
Power factor (approx.)	> 0.5 @ 230 V AC / > 0.53 @ 115 V AC
AC failure bridging time @ I _{Nenn}	> 100 ms @ 230 V AC / > 20 ms @ 115 V AC
Parallel connection option	yes, max. 5
Depth x width x height / Net weight	100 / 34 / 125 mm / 593 g

Approvals	
Approvals	CE; cULus; EAC; TUEV

Connection data	
Connection system	Screw connection
Number of terminals	3 for L/N/PE
Wire cross-section, rigid min/max	0.5 / 6 mm ²
Wire cross-section, flexible min/max	0.5 / 2.5 mm ²
Wire cross-section, AWG/kcmil min/max	26 / 12
Tightening torque range	0.5 / 0.6

Note	

Type	Qty.	Order No.
PRO ECO 72W 12V 6A	1	1469570000

Note	
The internal varistor found in a switch-mode power supply does not replace the need for surge protection within a system.	

Input	
Rated input voltage	100...240 V AC (wide-range input)
Input voltage range AC	85...264 V AC (Derating @ 100 V AC)
Frequency range AC	47...63 Hz
DC input voltage range	80...370 V DC (Derating @ 120 V DC)
AC current consumption	1.25 A @ 230 V AC / 2.25 A @ 110 V AC
DC current consumption	0.4 A @ 370 V DC / 1.2 A @ 120 V DC
Input fuse (internal) / Inrush current	Yes / max. 40 A
Recommended back-up fuse	4 A / DI, safety fuse 6 A, Char. B, circuit breaker 3...5 A, Char. C, circuit breaker

Output	
Rated output voltage	12 V DC ± 1 %
Output voltage	10...16 V (adjustable via potentiometer)
Ramp-up time / Residual ripple, breaking spikes	≤ 100 ms / < 50 mV ss @ 12 V DC, 1 Nenn
Rated (nominal) output current @ U _{Nenn}	10 A @ 55 °C
Continuous output current @ U _{Rated}	10 A @ 55 °C, 7.5 A @ 70 °C
Capacitive load	unrestricted
Protection against inverse voltage	Yes

Signalling	
Indication	LED green (U _{output} > 21.6 V DC), LED yellow (I _{output} > 90% I _{Rated} typ.), LED red (overload, overtemperature, short-circuit, U _{output} < 20.4 V DC)
Floating contact / Contact load	Yes / max. 30 V DC / 1 A
Relay on/off	Output voltage >21.6 V DC / <20.4 V DC, Overload

General data	
Degree of efficiency	87 %
Power loss idling / nominal load / Power loss, nominal load	4 W / 20 W
Earth leakage current, max.	3.5 mA
Power factor (approx.)	> 0.5 @ 230 V AC / > 0.53 @ 115 V AC
AC failure bridging time @ I _{Nenn}	> 80 ms @ 230 V AC / > 20 ms @ 115 V AC
Parallel connection option	yes, max. 5
Depth x width x height / Net weight	100 / 40 / 125 mm / 690 g

Approvals	
Approvals	CE; cULus; EAC; TUEV

Connection data	
Connection system	Screw connection
Number of terminals	3 for L/N/PE
Wire cross-section, rigid min/max	0.5 / 6 mm ²
Wire cross-section, flexible min/max	0.5 / 2.5 mm ²
Wire cross-section, AWG/kcmil min/max	26 / 12
Tightening torque range	0.5 / 0.6

Note	

Type	Qty.	Order No.
PRO ECO 120W 12V 10A	1	1469580000

Note	
The internal varistor found in a switch-mode power supply does not replace the need for surge protection within a system.	

connectPower PROeco

PRO ECO 240W 48V 5A

PRO ECO 480W 48V 10A

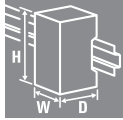

Similar to illustration



Similar to illustration

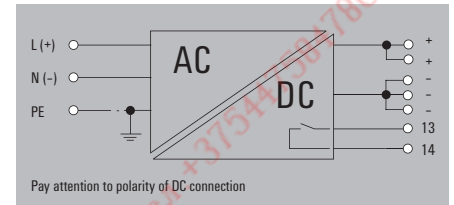
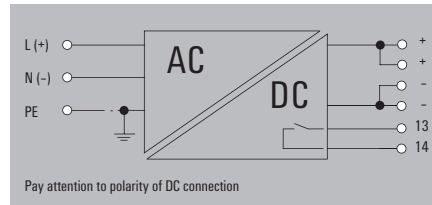

Technical data

Input	
Rated input voltage	100...240 V AC (wide-range input)
Input voltage range AC	85...264 V AC (Derating @ 100 V AC)
Frequency range AC	47...63 Hz
DC input voltage range	80...370 V DC (Derating @ 120 V DC)
AC current consumption	1.2 A @ 230 V AC / 2.4 A @ 115 V AC
DC current consumption	1.2 A @ 370 V DC / 2.4 A @ 120 V DC
Input fuse (internal) / Inrush current	Yes / Max. 10 A
Recommended back-up fuse	4 A / DI, safety fuse 10 A, Char. B, circuit breaker 3...4 A, Char. C, circuit breaker

Output	
Rated output voltage	48 V DC ± 1 %
Output voltage	42...56 V (adjustable via potentiometer)
Ramp-up time / Residual ripple, breaking spikes	≤ 100 ms / < 100 mV ss @ 48 V DC, I Nenn
Rated (nominal) output current @ U _{Nom}	5 A at 55 °C
Continuous output current @ U _{Rated}	5 A @ 55 °C, 3.75 A @ 70 °C
Capacitive load	unrestricted
Protection against inverse voltage	Yes

Signalling	
Indication	LED green (U _{output} > 21.6 V DC), LED yellow (I _{output} > 90% I _{Rated} typ.), LED red (overload, overtemperature, short-circuit, U _{output} < 20.4 V DC)
Floating contact / Contact load	Yes / max. 30 V DC / 1 A
Relay on/off	Output voltage >21.6 V DC / <20.4 V DC, Overload

General data	
Degree of efficiency	92 %
Power loss idling / nominal load / Power loss, nominal load	5 W / 50 W
Earth leakage current, max.	3.5 mA
Power factor (approx.)	> 0.94 @ 230 V AC / > 0.99 @ 115 V AC
AC failure bridging time @ I _{Nom}	> 20 ms @ 230 V AC / > 20 ms @ 115 V AC
Parallel connection option	yes, max. 5
Depth x width x height / Net weight	100 / 60 / 125 mm / 996 g

Approvals	
Approvals	CE; cULus; EAC

Connection data	
Connection system	Screw connection
Number of terminals	3 for L/N/PE
Wire cross-section, rigid min/max	0.5 / 6 mm ²
Wire cross-section, flexible min/max	0.5 / 2.5 mm ²
Wire cross-section, AWG/kcmil min/max	26 / 12
Tightening torque range	0.5 / 0.6

Note	

Ordering data

Type	Qty.	Order No.
PRO ECO 240W 48V 5A	1	1469590000

Note	
The internal varistor found in a switch-mode power supply does not replace the need for surge protection within a system.	

Rated input voltage	100...240 V AC (wide-range input)
Input voltage range AC	85...264 V AC (Derating @ 100 V AC)
Frequency range AC	47...63 Hz
DC input voltage range	80...370 V DC (Derating @ 120 V DC)
AC current consumption	1.2 A @ 230 V AC / 2.4 A @ 115 V AC
DC current consumption	1.2 A @ 370 V DC / 2.4 A @ 120 V DC
Input fuse (internal) / Inrush current	Yes / Max. 10 A
Recommended back-up fuse	4 A / DI, safety fuse 10 A, Char. B, circuit breaker 3...4 A, Char. C, circuit breaker

Rated output voltage	48 V DC ± 1 %
Output voltage	42...56 V (adjustable via potentiometer)
Ramp-up time / Residual ripple, breaking spikes	≤ 100 ms / < 100 mV ss @ 48 V DC, I Nenn
Rated (nominal) output current @ U _{Nom}	5 A at 55 °C
Continuous output current @ U _{Rated}	5 A @ 55 °C, 3.75 A @ 70 °C
Capacitive load	unrestricted
Protection against inverse voltage	Yes

Indication	LED green (U _{output} > 21.6 V DC), LED yellow (I _{output} > 90% I _{Rated} typ.), LED red (overload, overtemperature, short-circuit, U _{output} < 20.4 V DC)
Floating contact / Contact load	Yes / max. 30 V DC / 1 A
Relay on/off	Output voltage >21.6 V DC / <20.4 V DC, Overload

Degree of efficiency	92 %
Power loss idling / nominal load / Power loss, nominal load	5 W / 50 W
Earth leakage current, max.	3.5 mA
Power factor (approx.)	> 0.94 @ 230 V AC / > 0.99 @ 115 V AC
AC failure bridging time @ I _{Nom}	> 20 ms @ 230 V AC / > 20 ms @ 115 V AC
Parallel connection option	yes, max. 5
Depth x width x height / Net weight	100 / 60 / 125 mm / 996 g

Approvals	CE; cULus; EAC
-----------	----------------

Input		Output	
Connection system	Screw connection	Connection system	Screw connection
Number of terminals	3 for L/N/PE	Number of terminals	6 (+, -, 13, 14)
Wire cross-section, rigid min/max	0.5 / 6	Wire cross-section, rigid min/max	0.5 / 6
Wire cross-section, flexible min/max	0.5 / 2.5	Wire cross-section, flexible min/max	0.5 / 2.5
Wire cross-section, AWG/kcmil min/max	26 / 12	Wire cross-section, AWG/kcmil min/max	26 / 12
Tightening torque range	0.5 / 0.6	Tightening torque range	0.5 / 0.6

Note	

Rated input voltage	100...240 V AC (wide-range input)
Input voltage range AC	85...264 V AC (Derating @ 100 V AC)
Frequency range AC	47...63 Hz
DC input voltage range	80...370 V DC (Derating @ 120 V DC)
AC current consumption	2.4 A @ 230 V AC / 5.2 A @ 110 V AC
DC current consumption	1.5 A @ 370 V DC / 4.6 A @ 120 V DC
Input fuse (internal) / Inrush current	Yes / max. 3 A
Recommended back-up fuse	6 A / DI, safety fuse 16 A, Char. B, circuit breaker 6...8 A, Char. C, circuit breaker

Rated output voltage	48 V DC ± 1 %
Output voltage	42...56 V (adjustable via potentiometer)
Ramp-up time / Residual ripple, breaking spikes	≤ 100 ms / < 100 mV ss @ 48 V DC, I Nenn
Rated (nominal) output current @ U _{Nom}	10 A @ 55 °C
Continuous output current @ U _{Rated}	10 A @ 55 °C, 7.5 A @ 70 °C
Capacitive load	unrestricted
Protection against inverse voltage	Yes

Indication	LED green (U _{output} > 21.6 V DC), LED yellow (I _{output} > 90% I _{Rated} typ.), LED red (overload, overtemperature, short-circuit, U _{output} < 20.4 V DC)
Floating contact / Contact load	Yes / max. 30 V DC / 1 A
Relay on/off	Output voltage >21.6 V DC / <20.4 V DC, Overload

Degree of efficiency	93%
Power loss idling / nominal load / Power loss, nominal load	3 W / 23 W
Earth leakage current, max.	3.5 mA
Power factor (approx.)	> 0.98 @ 230 V AC / > 0.98 @ 115 V AC
AC failure bridging time @ I _{Nom}	> 20 ms @ 230 V AC / > 20 ms @ 115 V AC
Parallel connection option	yes, max. 3
Depth x width x height / Net weight	120 / 100 / 125 mm / 1570 g

Approvals	CE; cULus; EAC; TUEV
-----------	----------------------

Input		Output	
Connection system	Screw connection	Connection system	Screw connection
Number of terminals	3 for L/N/PE	Number of terminals	7 (+, -, 13, 14)
Wire cross-section, rigid min/max	0.5 / 6	Wire cross-section, rigid min/max	0.5 / 6
Wire cross-section, flexible min/max	0.5 / 2.5	Wire cross-section, flexible min/max	0.22 / 4
Wire cross-section, AWG/kcmil min/max	26 / 12	Wire cross-section, AWG/kcmil min/max	26 / 10
Tightening torque range	0.5 / 0.6	Tightening torque range	0.5 / 0.6

Note	

Type	Qty.	Order No.
PRO ECO 480W 48V 10A	1	1469610000

Note	
The internal varistor found in a switch-mode power supply does not replace the need for surge protection within a system.	

connectPower PROeco

connectPower PROeco

PRO ECO3 120W 24V 5A

PRO ECO3 240W 24V 10A

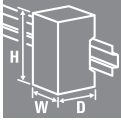

Similar to illustration



Similar to illustration

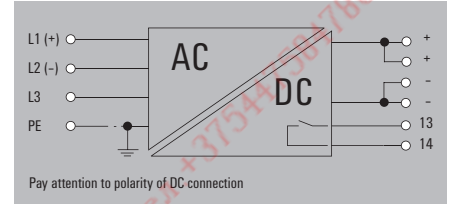
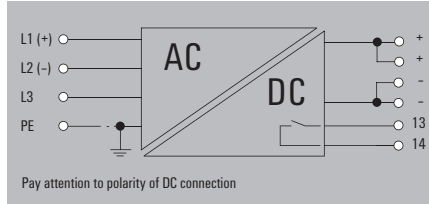

Technical data

Input	
Rated input voltage	3 x 400...3 x 500 V AC (wide-range input)
Input voltage range AC	3 x 320...3 x 575 V AC / 2 x 360...2 x 575 V AC
Frequency range AC	47...63 Hz
DC input voltage range	450...800 V DC (max. 500 V DC acc. to UL508)
AC current consumption	0.3 A @ 3 x 500 V AC / 0.4 A @ 3 x 400 V AC
DC current consumption	0.2 A @ 800 V DC / 0.4 A @ 450 V DC
Input fuse (internal) / Inrush current	Yes / max. 40 A
Recommended back-up fuse	2 A / DI, safety fuse 2...3 A, Char. C, circuit breaker

Output	
Rated output voltage	24 V DC ± 1 %
Output voltage	22...28 V (adjustable via potentiometer)
Ramp-up time / Residual ripple, breaking spikes	≤ 100 ms / < 50 mV _{SS} @ 24 V DC, I _N
Rated (nominal) output current @ U _{Nom}	5 A at 55 °C
Continuous output current @ U _{Rated}	5 A @ 55 °C, 3,75 A @ 70 °C
Capacitive load	unrestricted
Protection against inverse voltage	Yes

Signalling	
Indication	LED green (U _{output} > 21.6 V DC), LED yellow (I _{output} > 90% I _{Rated} typ.), LED red (overload, overtemperature, short-circuit, U _{output} < 20.4 V DC)
Floating contact / Contact load	Yes / max. 30 V DC / 1 A
Relay on/off	Output voltage >21.6 V DC / <20.4 V DC, Overload

General data	
Degree of efficiency	87 %
Power loss idling / nominal load / Power loss, nominal load	6 W / 13 W
Earth leakage current, max.	3.5 mA
Power factor (approx.)	> 0.55 @ 3 x 500 V AC / > 0.65 @ 3 x 400 V AC
AC failure bridging time @ I _{Nom}	> 40 ms @ 3 x 500 V AC / > 20 ms @ 3 x 400 V AC
Parallel connection option	yes, max. 5
Depth x width x height / Net weight	100 / 40 / 125 mm / 705 g

Approvals	
Approvals	CE; cULus; EAC; TUEV

Connection data	
Connection system	Screw connection
Number of terminals	4 for L1/L2/L3/PE
Wire cross-section, rigid min/max	0.5 / 6 mm ²
Wire cross-section, flexible min/max	0.5 / 2.5 mm ²
Wire cross-section, AWG/kcmil min/max	26 / 12
Tightening torque range	0.5 / 0.6

Note	

Ordering data

Type	Qty.	Order No.
PRO ECO3 120W 24V 5A	1	1469530000

Note	
The internal varistor found in a switch-mode power supply does not replace the need for surge protection within a system.	

Input	
Rated input voltage	3 x 400...3 x 500 V AC (wide-range input)
Input voltage range AC	3 x 320...3 x 575 V AC / 2 x 360...2 x 575 V AC
Frequency range AC	47...63 Hz
DC input voltage range	450...800 V DC (max. 500 V DC acc. to UL508)
AC current consumption	0.3 A @ 3 x 500 V AC / 0.4 A @ 3 x 400 V AC
DC current consumption	0.2 A @ 800 V DC / 0.4 A @ 450 V DC
Input fuse (internal) / Inrush current	Yes / max. 40 A
Recommended back-up fuse	2 A / DI, safety fuse 2...3 A, Char. C, circuit breaker

Output	
Rated output voltage	24 V DC ± 1 %
Output voltage	22...28 V (adjustable via potentiometer)
Ramp-up time / Residual ripple, breaking spikes	≤ 100 ms / < 50 mV _{SS} @ 24 V DC, I _N
Rated (nominal) output current @ U _{Nom}	10 A at 55 °C
Continuous output current @ U _{Rated}	10 A @ 55 °C, 7.5 A @ 70 °C
Capacitive load	unrestricted
Protection against inverse voltage	Yes

Signalling	
Indication	LED green (U _{output} > 21.6 V DC), LED yellow (I _{output} > 90% I _{Rated} typ.), LED red (overload, overtemperature, short-circuit, U _{output} < 20.4 V DC)
Floating contact / Contact load	Yes / max. 30 V DC / 1 A
Relay on/off	Output voltage >21.6 V DC / <20.4 V DC, Overload

General data	
Degree of efficiency	88 %
Power loss idling / nominal load / Power loss, nominal load	6 W / 24 W
Earth leakage current, max.	3.5 mA
Power factor (approx.)	> 0.55 @ 3 x 500 V AC / > 0.65 @ 3 x 400 V AC
AC failure bridging time @ I _{Nom}	> 40 ms @ 3 x 500 V AC / > 20 ms @ 3 x 400 V AC
Parallel connection option	yes, max. 5
Depth x width x height / Net weight	100 / 60 / 125 mm / 962 g

Approvals	
Approvals	CE; cULus; EAC; TUEV

Connection data	
Connection system	Screw connection
Number of terminals	4 for L1/L2/L3/PE
Wire cross-section, rigid min/max	0.5 / 6 mm ²
Wire cross-section, flexible min/max	0.5 / 2.5 mm ²
Wire cross-section, AWG/kcmil min/max	26 / 12
Tightening torque range	0.5 / 0.6

Note	

Type	Qty.	Order No.
PRO ECO3 240W 24V 10A	1	1469540000

Note	
The internal varistor found in a switch-mode power supply does not replace the need for surge protection within a system.	

Input	
Rated input voltage	3 x 400...3 x 500 V AC (wide-range input)
Input voltage range AC	3 x 320...3 x 575 V AC / 2 x 360...2 x 575 V AC
Frequency range AC	47...63 Hz
DC input voltage range	450...800 V DC (max. 500 V DC acc. to UL508)
AC current consumption	0.6 A @ 3 x 500 V AC / 0.8 A @ 3 x 400 V AC
DC current consumption	0.4 A @ 800 V DC / 0.7 A @ 450 V DC
Input fuse (internal) / Inrush current	Yes / max. 50 A
Recommended back-up fuse	2 A / DI, safety fuse 2...3 A, Char. C, circuit breaker

Output	
Rated output voltage	24 V DC ± 1 %
Output voltage	22...28 V (adjustable via potentiometer)
Ramp-up time / Residual ripple, breaking spikes	≤ 100 ms / < 50 mV _{SS} @ 24 V DC, I _N
Rated (nominal) output current @ U _{Nom}	10 A at 55 °C
Continuous output current @ U _{Rated}	10 A @ 55 °C, 7.5 A @ 70 °C
Capacitive load	unrestricted
Protection against inverse voltage	Yes

Signalling	
Indication	LED green (U _{output} > 21.6 V DC), LED yellow (I _{output} > 90% I _{Rated} typ.), LED red (overload, overtemperature, short-circuit, U _{output} < 20.4 V DC)
Floating contact / Contact load	Yes / max. 30 V DC / 1 A
Relay on/off	Output voltage >21.6 V DC / <20.4 V DC, Overload

General data	
Degree of efficiency	88 %
Power loss idling / nominal load / Power loss, nominal load	6 W / 24 W
Earth leakage current, max.	3.5 mA
Power factor (approx.)	> 0.55 @ 3 x 500 V AC / > 0.65 @ 3 x 400 V AC
AC failure bridging time @ I _{Nom}	> 40 ms @ 3 x 500 V AC / > 20 ms @ 3 x 400 V AC
Parallel connection option	yes, max. 5
Depth x width x height / Net weight	100 / 60 / 125 mm / 962 g

Approvals	
Approvals	CE; cULus; EAC; TUEV

Connection data	
Connection system	Screw connection
Number of terminals	4 for L1/L2/L3/PE
Wire cross-section, rigid min/max	0.5 / 6 mm ²
Wire cross-section, flexible min/max	0.5 / 2.5 mm ²
Wire cross-section, AWG/kcmil min/max	26 / 12
Tightening torque range	0.5 / 0.6

Note	

Type	Qty.	Order No.
PRO ECO3 240W 24V 10A	1	1469540000

Note	
The internal varistor found in a switch-mode power supply does not replace the need for surge protection within a system.	

connectPower PROeco

PRO ECO3 480W 24V 20A

PRO ECO3 960W 24V 40A

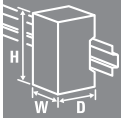

Similar to illustration



Similar to illustration

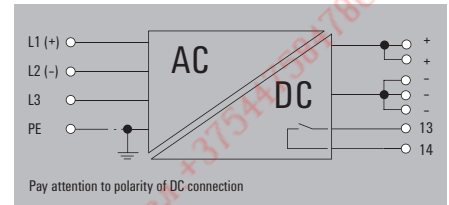
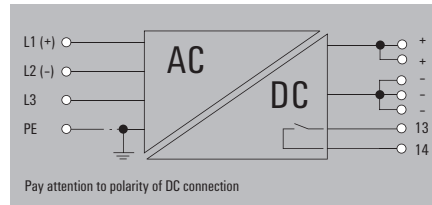

Technical data

Input	
Rated input voltage	3 x 400...3 x 500 V AC (wide-range input)
Input voltage range AC	3 x 320...3 x 575 V AC / 2 x 360...2 x 575 V AC
Frequency range AC	47...63 Hz
DC input voltage range	450...800 V DC (max. 500 V DC acc. to UL508)
AC current consumption	1.2 A @ 3 x 500 V AC / 1.5 A @ 3 x 400 V AC
DC current consumption	0.7 A @ 800 V DC / 1.2 A @ 450 V DC
Input fuse (internal) / Inrush current	Yes / max. 50 A
Recommended back-up fuse	4 A / DI, safety fuse 3...5 A, Char. C, circuit breaker

Output	
Rated output voltage	24 V DC ± 1 %
Output voltage	22...28 V (adjustable via potentiometer)
Ramp-up time / Residual ripple, breaking spikes	≤ 100 ms / < 50 mV _{SS} @ 24 V DC, I _N
Rated (nominal) output current @ U _{Nom}	20 A @ 55 °C
Continuous output current @ U _{Rated}	20 A @ 55 °C, 15 A @ 70 °C
Capacitive load	unrestricted
Protection against inverse voltage	Yes

Signalling	
Indication	LED green (U _{output} > 21.6 V DC), LED yellow (I _{output} > 90% I _{Rated} typ.), LED red (overload, overtemperature, short-circuit, U _{output} < 20.4 V DC)
Floating contact / Contact load	Yes / max. 30 V DC / 1 A
Relay on/off	Output voltage >21.6 V DC / <20.4 V DC, Overload

General data	
Degree of efficiency	89%
Power loss idling / nominal load / Power loss, nominal load	8 W / 48 W
Earth leakage current, max.	3.5 mA
Power factor (approx.)	> 0.55 @ 3 x 500 V AC / > 0.65 @ 3 x 400 V AC
AC failure bridging time @ I _{Nom}	> 30 ms @ 3 x 500 V AC / > 20 ms @ 3 x 400 V AC
Parallel connection option	yes, max. 3
Depth x width x height / Net weight	120 / 100 / 125 mm / 1490 g

Approvals	
Approvals	CE; cULus; EAC; TUEV

Connection data	
Connection system	Screw connection
Number of terminals	4 for L1/L2/L3/PE
Wire cross-section, rigid min/max	0.5 / 6 mm ²
Wire cross-section, flexible min/max	0.5 / 2.5 mm ²
Wire cross-section, AWG/kcmil min/max	26 / 12
Tightening torque range	0.5 / 0.6

Note	

Ordering data

Type	Qty.	Order No.
PRO ECO3 480W 24V 20A	1	1469550000

Note	
The internal varistor found in a switch-mode power supply does not replace the need for surge protection within a system.	

Input	
Rated input voltage	3 x 400...3 x 500 V AC (wide-range input)
Input voltage range AC	3 x 320...3 x 575 V AC / 2 x 360...2 x 575 V AC
Frequency range AC	47...63 Hz
DC input voltage range	450...800 V DC (max. 500 V DC acc. to UL508)
AC current consumption	1.2 A @ 3 x 500 V AC / 1.5 A @ 3 x 400 V AC
DC current consumption	0.7 A @ 800 V DC / 1.2 A @ 450 V DC
Input fuse (internal) / Inrush current	Yes / max. 50 A
Recommended back-up fuse	4 A / DI, safety fuse 3...5 A, Char. C, circuit breaker

Output	
Rated output voltage	24 V DC ± 1 %
Output voltage	22...28 V (adjustable via potentiometer)
Ramp-up time / Residual ripple, breaking spikes	≤ 100 ms / < 50 mV _{SS} @ 24 V DC, I _N
Rated (nominal) output current @ U _{Nom}	20 A @ 55 °C
Continuous output current @ U _{Rated}	20 A @ 55 °C, 15 A @ 70 °C
Capacitive load	unrestricted
Protection against inverse voltage	Yes

Signalling	
Indication	LED green (U _{output} > 21.6 V DC), LED yellow (I _{output} > 90% I _{Rated} typ.), LED red (overload, overtemperature, short-circuit, U _{output} < 20.4 V DC)
Floating contact / Contact load	Yes / max. 30 V DC / 1 A
Relay on/off	Output voltage >21.6 V DC / <20.4 V DC, Overload

General data	
Degree of efficiency	90%
Power loss idling / nominal load / Power loss, nominal load	5 W / 95 W
Earth leakage current, max.	3.5 mA
Power factor (approx.)	> 0.55 @ 3 x 500 V AC / > 0.65 @ 3 x 400 V AC
AC failure bridging time @ I _{Nom}	> 25 ms @ 3 x 500 V AC / > 20 ms @ 3 x 400 V AC
Parallel connection option	yes, max. 3
Depth x width x height / Net weight	120 / 160 / 125 mm / 2899 g

Approvals	
Approvals	CE; cULus; EAC; TUEV

Connection data	
Connection system	Screw connection
Number of terminals	4 for L1/L2/L3/PE
Wire cross-section, rigid min/max	0.5 / 6 mm ²
Wire cross-section, flexible min/max	0.5 / 2.5 mm ²
Wire cross-section, AWG/kcmil min/max	26 / 12
Tightening torque range	0.5 / 0.6

Note	

Type	Qty.	Order No.
PRO ECO3 960W 24V 40A	1	1469560000

Note	
The internal varistor found in a switch-mode power supply does not replace the need for surge protection within a system.	

Input	
Rated input voltage	3 x 400...3 x 500 V AC (wide-range input)
Input voltage range AC	3 x 320...3 x 575 V AC / 2 x 360...2 x 575 V AC
Frequency range AC	47...63 Hz
DC input voltage range	450...800 V DC (max. 500 V DC acc. to UL508)
AC current consumption	2.15 A @ 3 x 500 V AC / 2.68 A @ 3 x 400 V AC
DC current consumption	1.37 A @ 800 V DC / 2.37 A @ 450 V DC
Input fuse (internal) / Inrush current	Yes / max. 40 A
Recommended back-up fuse	6 A / DI, safety fuse 10 A, Char. B, circuit breaker 6...8 A, Char. C, circuit breaker

Output	
Rated output voltage	24 V DC ± 1 %
Output voltage	22...28 V (adjustable via potentiometer)
Ramp-up time / Residual ripple, breaking spikes	≤ 100 ms / < 50 mV _{SS} @ 24 V DC, I _N
Rated (nominal) output current @ U _{Nom}	40 A @ 50 °C
Continuous output current @ U _{Rated}	40 A @ 50 °C, 24 A @ 70 °C
Capacitive load	unrestricted
Protection against inverse voltage	Yes

Signalling	
Indication	LED green (U _{output} > 21.6 V DC), LED yellow (I _{output} > 90% I _{Rated} typ.), LED red (overload, overtemperature, short-circuit, U _{output} < 20.4 V DC)
Floating contact / Contact load	Yes / max. 30 V DC / 1 A
Relay on/off	Output voltage >21.6 V DC / <20.4 V DC, Overload

General data	
Degree of efficiency	90%
Power loss idling / nominal load / Power loss, nominal load	5 W / 95 W
Earth leakage current, max.	3.5 mA
Power factor (approx.)	> 0.55 @ 3 x 500 V AC / > 0.65 @ 3 x 400 V AC
AC failure bridging time @ I _{Nom}	> 25 ms @ 3 x 500 V AC / > 20 ms @ 3 x 400 V AC
Parallel connection option	yes, max. 3
Depth x width x height / Net weight	120 / 160 / 125 mm / 2899 g

Approvals	
Approvals	CE; cULus; EAC; TUEV

Connection data	
Connection system	Screw connection
Number of terminals	4 for L1/L2/L3/PE
Wire cross-section, rigid min/max	0.5 / 6 mm ²
Wire cross-section, flexible min/max	0.5 / 2.5 mm ²
Wire cross-section, AWG/kcmil min/max	26 / 12
Tightening torque range	0.5 / 0.6

Note	

Type	Qty.	Order No.
PRO ECO3 960W 24V 40A	1	1469560000

Note	
The internal varistor found in a switch-mode power supply does not replace the need for surge protection within a system.	

connectPower PROeco diode module

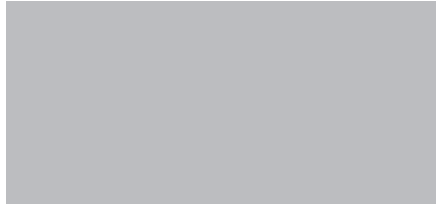
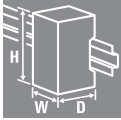

Technical data

Input	
DC input voltage range	
DC current consumption	
Output	
Rated output voltage	
Continuous output current @ U_{Rated}	
General data	
Ambient temperature (operational)	
Storage temperature	
Derating	
Degree of efficiency	
Mounting position, installation notice	
Depth x width x height / Net weight	
Approvals	

PRO DM 10

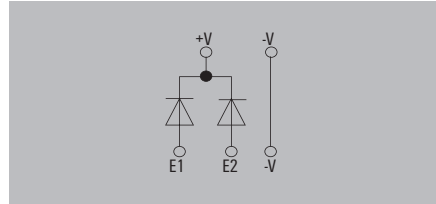

DC input voltage range	0...60 V DC
DC current consumption	2 × 12 A (-40 °C ~ +45 °C), 2 × 10 A (+45 °C ~ +60 °C), 2 × 7.5 A (+70 °C)
Rated output voltage	24 V DC ± 1 %
Continuous output current @ U_{Rated}	1 × 24 A (-40 °C ~ +45 °C), 1 × 20 A (+45 °C ~ +60 °C), 1 × 15 A (+70 °C)
Ambient temperature (operational)	-40 °C...70 °C
Storage temperature	-40 °C...85 °C
Derating	> 60°C / 75% load @ 70°C
Degree of efficiency	> 97% @ 24 V input voltage
Mounting position, installation notice	Horizontal on TS35 mounting rail. 50 mm of clearance at top & bottom for air circ. Can mount side by side with no space in between.
Depth x width x height / Net weight	125 / 32 / 125 mm / 518 g

PRO DM 20

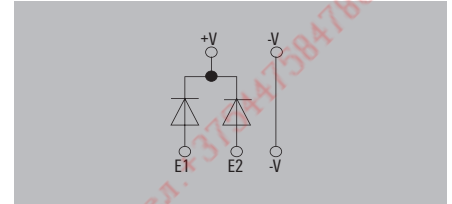

DC input voltage range	0...60 V DC
DC current consumption	2 × 24 A (-40 °C ~ +45 °C), 2 × 20 A (+40 °C ~ +60 °C), 2 × 15 A (+70 °C)
Rated output voltage	24 V DC ± 1 %
Continuous output current @ U_{Rated}	1 × 48 A (-40 °C ~ +45 °C), 1 × 40 A (+45 °C ~ +60 °C), 1 × 30 A (+70 °C)
Ambient temperature (operational)	-40 °C...70 °C
Storage temperature	-40 °C...85 °C
Derating	> 60°C / 75% load @ 70°C
Degree of efficiency	> 97% @ 24 V input voltage
Mounting position, installation notice	Horizontal on TS35 mounting rail. 50 mm of clearance at top & bottom for air circ. Can mount side by side with no space in between.
Depth x width x height / Net weight	125 / 32 / 125 mm / 568 g

Connection data	
Connection system	
Number of terminals	
Wire cross-section, rigid min/max	mm ²
Wire cross-section, flexible min/max	mm ²
Wire cross-section, AWG/kcmil min/max	
Tightening torque range	
Note	

Input	Output
Screw connection	Screw connection
4 (1+, 2+, 1-, 2-)	4 (++, --)
0.18 / 6	0.18 / 6
0.22 / 4	0.22 / 6
26 / 10	26 / 10
	0.5 / 0.6

Input	Output
Screw connection	Screw connection
4 (1+, 2+, 1-, 2-)	4 (++, --)
0.18 / 6	0.5 / 16
0.22 / 4	0.5 / 16
26 / 10	22 / 8
	1.2 / 1.5

Ordering data

Note	
Screw connection	

Type	Qty.	Order No.
PRO DM 10	1	2486070000

Type	Qty.	Order No.
PRO DM 20	1	2486080000

Small metal foot



Type	Order No.
MTA 30 MF	1251320000

Large metal foot



Type	Order No.
MTA 45 MF	1251310000

Small plastic foot



Type	Order No.
MTA 30 BK	1168970000

Large plastic foot



Type	Order No.
MTA 45 BK	1962250000

Small wall mounting



Type	Order No.
CP A WALLADAPTER 30 MM	1461870000

Large wall mounting



Type	Order No.
CP A WALLADAPTER 45 MM	1461850000

Small screwdriver



Type	Blade type	Size/AF	a	b	c	Order No.
SDIK PH1		1.00			80	9008570000
SDIS 0.5X3.0X100	B		0.5	3	100	9008380000

Markers



Type	Colour	Qty.	Order No.
SM 18/9.5 K MC NE WS	white	200	1248580000

End bracket

For DIN rail TS 35



Polyamide with fibre glass, screwable	Colour	Torque	Qty.	Order No.
WEW 35/1 SW	black	1.2 Nm	50	1162600000

connectPower
PROmax



Derating curve

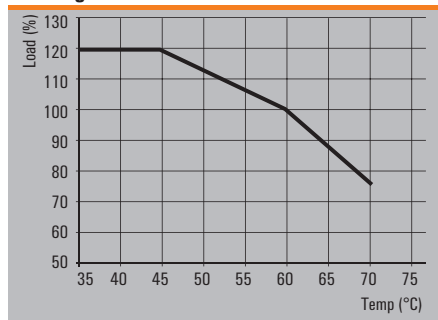

Permitted continuous limit currents [A]

Typ \ Temp.	45 °C	50 °C	55 °C	60 °C	65 °C	70 °C
1ph 24 V / 3 A	3,6	3,3	3,2	3	2,6	2,2
1ph 24 V / 5 A	6	5,7	5,4	5	4,4	3,8
1ph 24 V / 7,5 A	9	8,5	8	7,5	6,6	5,6
1ph 24 V / 10 A	12	11,3	10,7	10	8,8	7,5
1ph 24 V / 20 A	24	22,6	21,4	20	17,6	15
1ph 24 V / 40 A	48	45,2	42,8	40	35,2	30
1ph 5 V / 14 A	16,8	15,8	15	14	12,3	10,5
1ph 12 V / 6 A	7,2	6,8	6,4	6	5,3	4,5
1ph 12 V / 10 A	12	11,3	10,7	10	8,8	7,5
1ph 48 V / 5 A	6	5,7	5,4	5	4,4	3,8
1ph 48 V / 10 A	12	11,3	10,7	10	8,8	7,5
1ph 48 V / 20 A	24	22,6	21,4	20	17,6	15
3ph 24 V / 5 A	6	5,7	5,4	5	4,4	3,8
3ph 24 V / 10 A	12	11,3	10,7	10	8,8	7,5
3ph 24 V / 20 A	24	22,6	21,4	20	17,6	15
3ph 24 V / 40 A	48	45,2	42,8	40	35,2	30

Technical data

General data	
Current limiting	> 120 % I _N
Insulation voltage input / earth	3.5
Insulation voltage output / earth	0.5
Insulation voltage, input/output	4
Earth leakage current, max.	3.5
Series switching capability	Yes
Ambient temperature (operational) / Storage temperature / Start-up	-25 °C...70 °C / -40 °C...85 °C / ≥ -40 °C
Humidity at operating temperature	5...95 %, no condensation
Class of protection / Pollution degree	I, with PE connection / 2
MTBF	
Housing version	Metal, corrosion resistant
Status indication	LED red/green and relay (≥21.6 V DC LED green, relay on/ ≤20.6 LED red, relay off)
Mounting position, installation notice	Horizontal on TS35 mounting rail. 50 mm of clearance at top & bottom for air circ. Can mount side by side with no space in between.

EMC / shock / vibration	
Interference immunity test acc. to	EN 55024, EN 55022, IEC61000-3-2,-3, IEC61000-4-2,-3,-4,-5,-6,-8,-11
Shock	30 g in all directions
Resistance to vibration	2.3 g
Electrical safety (applied standards)	
Electrical machine equipment	Acc. to EN60204
Safety transformers for switch-mode power supplies	IEC61558-2-16
For use with electronic equipment	Acc. to EN50178 / VDE0160
Safety extra-low voltage	SELV acc. to EN60950, PELV acc. to EN60204, IEC61204
Protective separation / protection against electrical shock	VDE0100-410 / acc. to DIN57100-410
Protection against dangerous shock currents	Acc. to VDE0106-101

connectPower PROmax

PRO MAX 72W 24V 3A

PRO MAX 120W 24V 5A

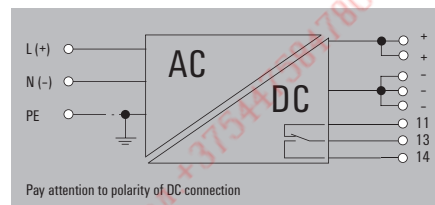
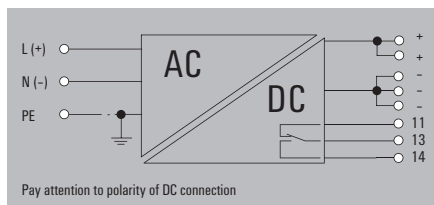

Technical data

Input
Rated input voltage
Input voltage range AC
Frequency range AC
DC input voltage range
AC current consumption
DC current consumption
Input fuse (internal) / Inrush current
Recommended back-up fuse

100...240 V AC (wide-range input)
85...277 V AC
45...65 Hz
80...370 V DC
1 A @ 230 V AC / 1.5 A @ 115 V AC
1A @ 370 VDC / 1,5A @ 120 VDC
Yes / max. 15 A
6 A, Char. B, circuit breaker, 3 - 5 A Char. C, circuit breaker

100...240 V AC (wide-range input)
85...277 V AC
45...65 Hz
80...370 V DC
1A @ 230 VAC / 2,5A @ 115 VAC
1,5A @ 370 VDC / 2,5A @ 120 VDC
Yes / max. 15 A
6 A, Char. B, circuit breaker, 6 A, char. C circuit breaker

Output
Rated output voltage
Output voltage
Residual ripple, breaking spikes
Rated (nominal) output current @ I_{Nom}
Continuous output current @ U_{Rated}
Leitungsreserve @ U_{Rated}
Pulsed current capacity @ U_{Rated}

24 V DC \pm 1 %
22.5...29.5 V (adjustable via potentiometer)
< 50 mVss @ U_{Nomin} , Full Load
3 A @ 60 °C
3,6 A @ 45°C, 2,25 A @ 70°C
3.6 A (1 min), 4.5 A (4s)
9 A (2ms)

24 V DC \pm 1 %
22.5...29.5 V (adjustable via potentiometer)
< 50 mVss @ U_{Nomin} , Full Load
5 A @ 60 °C
6.0 A @ 45 °C, 3,75 A @ 70 °C
6 A (1 min), 7.5 A (4s)
15 A (2ms)

General data
Degree of efficiency
Power factor (approx.)
AC failure bridging time @ I_{Nom}
Protection against reverse voltages from the load
Parallel connection option
Depth x width x height
Net weight

89%
> 0.90 @ 230 V AC
min. 20 ms
30...35 V DC
yes, max. 5
125 / 32 / 130 mm
650 g

89%
> 0.90 @ 230 V AC
min. 20 ms
30...35 V DC
yes, max. 5
125 / 40 / 130 mm
859 g

Approvals
Approvals

CE; cULus; cULusEX; cURus; EAC; GL; TUEV
--

CE; cULus; cULusEX; cURus; EAC; GL; TUEV
--

Connection data	
Connection system	
Number of terminals	
Wire cross-section, rigid min/max	mm ²
Wire cross-section, flexible min/max	mm ²
Wire cross-section, AWG/kcmil min/max	
Screwdriver blade	

Input	Output
Screw connection	Screw connection
3 for L/N/PE	8 (+,-,11,13,14)
0.18 / 6	0.5 / 6
0.22 / 4	0.5 / 4
26 / 10	26 / 12
0.8 x 4.0, PZ 1	0.6 x 3.5

Input	Output
Screw connection	Screw connection
3 for L/N/PE	8 (+,-,11,13,14)
0.18 / 6	0.5 / 6
0.22 / 4	0.5 / 4
26 / 10	26 / 12
0.8 x 4.0, PZ 1	0.6 x 3.5

Note

Ordering data

Type	Qty.	Order No.
PRO MAX 72W 24V 3A	1	147810000

Type	Qty.	Order No.
PRO MAX 120W 24V 5A	1	147811000

Type	Qty.	Order No.
PRO MAX 120W 24V 5A	1	147811000

Note
The internal varistor found in a switch-mode power supply does not replace the need for surge protection within a system.

Note
The internal varistor found in a switch-mode power supply does not replace the need for surge protection within a system.

Note
The internal varistor found in a switch-mode power supply does not replace the need for surge protection within a system.

Accessories

Note

connectPower PROmax

connectPower PROmax

PRO MAX 180W 24V 7,5A

PRO MAX 240W 24V 10A

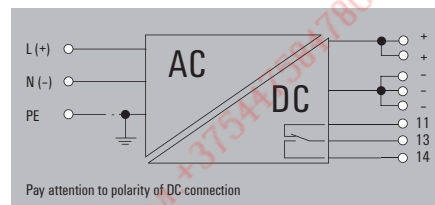
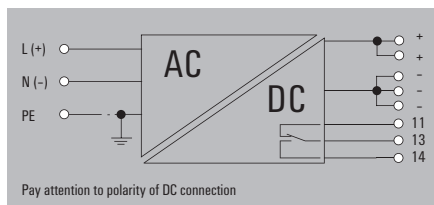

Technical data

Input	
Rated input voltage	100...240 V AC (wide-range input)
Input voltage range AC	85...277 V AC
Frequency range AC	45...65 Hz
DC input voltage range	80...370 V DC
AC current consumption	1 A @ 230 V AC / 2 A @ 115 V AC
DC current consumption	1 A @ 370 VDC / 2 A @ 120 VDC
Input fuse (internal) / Inrush current	Yes / max. 15 A
Recommended back-up fuse	10 A, char. B circuit breaker, 6...8 A, char. C circuit breaker

Output	
Rated output voltage	24 V DC ± 1 %
Output voltage	22.5...29.5 V (adjustable via potentiometer)
Residual ripple, breaking spikes	< 50 mVss @ U _{Nom} , Full Load
Rated (nominal) output current @ U _{Nom}	7,5 A @ 60 °C
Continuous output current @ U _{Rated}	9 A @ 45°C, 5,6 A @ 70°C
Leitungsreserve @ U _{Rated}	9 A (1 min), 11,25 A (4s)
Pulsed current capacity @ U _{Rated}	22,5 A (2ms)

General data	
Degree of efficiency	91.5%
Power factor (approx.)	> 0.95 @ 230 V AC
AC failure bridging time @ I _{Nom}	min. 20 ms
Protection against reverse voltages from the load	30...35 V DC
Parallel connection option	yes, max. 5
Depth x width x height	125 / 50 / 130 mm
Net weight	950 g

Approvals	
Approvals	CE; cULus; cULusEX; cURus; EAC; GL; TUEV

Connection data	
Connection system	Screw connection
Number of terminals	3 for L/N/PE
Wire cross-section, rigid min/max	0.18 / 6 mm ²
Wire cross-section, flexible min/max	0.22 / 4 mm ²
Wire cross-section, AWG/kcmil min/max	26 / 10
Screwdriver blade	0.8 x 4.0, PZ 1

Note	

Ordering data

Type	Qty.	Order No.
PRO MAX 180W 24V 7,5A	1	1478120000

Note	
The internal varistor found in a switch-mode power supply does not replace the need for surge protection within a system.	

Accessories

Note	

Input	
Rated input voltage	100...240 V AC (wide-range input)
Input voltage range AC	85...277 V AC
Frequency range AC	45...65 Hz
DC input voltage range	80...370 V DC
AC current consumption	1 A @ 230 V AC / 2 A @ 115 V AC
DC current consumption	1 A @ 370 VDC / 2 A @ 120 VDC
Input fuse (internal) / Inrush current	Yes / max. 15 A
Recommended back-up fuse	10 A, char. B circuit breaker, 6...8 A, char. C circuit breaker

Output	
Rated output voltage	24 V DC ± 1 %
Output voltage	22.5...29.5 V (adjustable via potentiometer)
Residual ripple, breaking spikes	< 50 mVss @ U _{Nom} , Full Load
Rated (nominal) output current @ U _{Nom}	7,5 A @ 60 °C
Continuous output current @ U _{Rated}	9 A @ 45°C, 5,6 A @ 70°C
Leitungsreserve @ U _{Rated}	9 A (1 min), 11,25 A (4s)
Pulsed current capacity @ U _{Rated}	22,5 A (2ms)

General data	
Degree of efficiency	91.5%
Power factor (approx.)	> 0.95 @ 230 V AC
AC failure bridging time @ I _{Nom}	min. 20 ms
Protection against reverse voltages from the load	30...35 V DC
Parallel connection option	yes, max. 5
Depth x width x height	125 / 50 / 130 mm
Net weight	950 g

Approvals	
Approvals	CE; cULus; cULusEX; cURus; EAC; GL; TUEV

Connection data	
Connection system	Screw connection
Number of terminals	3 for L/N/PE
Wire cross-section, rigid min/max	0.18 / 6 mm ²
Wire cross-section, flexible min/max	0.22 / 4 mm ²
Wire cross-section, AWG/kcmil min/max	26 / 10
Screwdriver blade	0.8 x 4.0, PZ 1

Note	

Type	Qty.	Order No.
PRO MAX 240W 24V 10A	1	1478130000

Note	
The internal varistor found in a switch-mode power supply does not replace the need for surge protection within a system.	

Note	

Input	
Rated input voltage	100...240 V AC (wide-range input)
Input voltage range AC	85...277 V AC
Frequency range AC	45...65 Hz
DC input voltage range	80...370 V DC
AC current consumption	1.5 A @ 230 V AC / 3 A @ 115 V AC
DC current consumption	1,5A @ 370 VDC / 3A @ 120 VDC
Input fuse (internal) / Inrush current	Yes / max. 15 A
Recommended back-up fuse	10 A, char. B circuit breaker, 6...8 A, char. C circuit breaker

Output	
Rated output voltage	24 V DC ± 1 %
Output voltage	22.5...29.5 V (adjustable via potentiometer)
Residual ripple, breaking spikes	< 50 mVss @ U _{Nom} , Full Load
Rated (nominal) output current @ U _{Nom}	10 A @ 60 °C
Continuous output current @ U _{Rated}	12 A @ 45°C, 7,5 A @ 70°C
Leitungsreserve @ U _{Rated}	12 A (1 min), 15 A (4s)
Pulsed current capacity @ U _{Rated}	30 A (2ms)

General data	
Degree of efficiency	91.5%
Power factor (approx.)	> 0.95 @ 230 V AC
AC failure bridging time @ I _{Nom}	min. 20 ms
Protection against reverse voltages from the load	30...35 V DC
Parallel connection option	yes, max. 5
Depth x width x height	125 / 60 / 130 mm
Net weight	1050 g

Approvals	
Approvals	CE; cULus; cULusEX; cURus; EAC; GL; TUEV

Connection data	
Connection system	Screw connection
Number of terminals	3 for L/N/PE
Wire cross-section, rigid min/max	0.18 / 6 mm ²
Wire cross-section, flexible min/max	0.22 / 4 mm ²
Wire cross-section, AWG/kcmil min/max	26 / 10
Screwdriver blade	0.8 x 4.0, PZ 1

Note	

Type	Qty.	Order No.
PRO MAX 240W 24V 10A	1	1478130000

Note	
The internal varistor found in a switch-mode power supply does not replace the need for surge protection within a system.	

Note	

connectPower PROmax

PRO MAX 480W 24V 20A

PRO MAX 960W 24V 40A

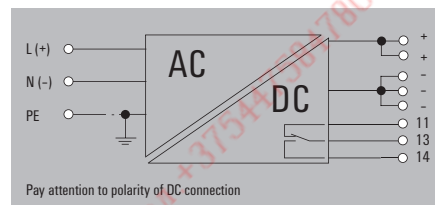
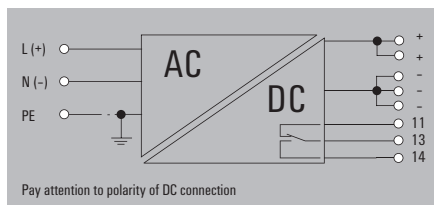

Technical data

Input
Rated input voltage
Input voltage range AC
Frequency range AC
DC input voltage range
AC current consumption
DC current consumption
Input fuse (internal) / Inrush current
Recommended back-up fuse

100...240 V AC (wide-range input)
85...277 V AC
45...65 Hz
80...370 V DC
2,3A @ 230 VAC / 4,8A @ 115 VAC
1,5A @ 370 VDC / 4,8A @ 120 VDC
Yes / max. 15 A
16 A, Char. B circuit breaker, 10 A, char. C circuit breaker

100...240 V AC (wide-range input)
85...277 V AC
45...65 Hz
80...370 V DC
4,52A @ 230 VAC / 10A @ 115 VAC
2,8A @ 370 VDC / 10A @ 120 VDC
Yes / max. 15 A
20 A, char. B circuit breaker, 16 A, Char. C circuit breaker

Output
Rated output voltage
Output voltage
Residual ripple, breaking spikes
Rated (nominal) output current @ U _{Nom}
Continuous output current @ U _{Rated}
Leitungsreserve @ U _{Rated}
Pulsed current capacity @ U _{Rated}

24 V DC ± 1 %
22.5...29.5 V (adjustable via potentiometer)
< 50 mVss @ U _{Nom} , Full Load
20 A @ 60 °C
24 A @ 45°C, 15 A @ 70°C
24 A (1 min), 30 A (4s), 100...240 V AC
60 A (2ms)

24 V DC ± 1 %
22.5...29.5 V (adjustable via potentiometer)
< 50 mVss @ U _{Nom} , Full Load
40 A @ 60 °C
48 A @ 45°C, 30 A @ 70°C
48 A (1 min), 60 A (4s), 100...240 V AC
120 A (2ms)

General data
Degree of efficiency
Power factor (approx.)
AC failure bridging time @ I _{Nom}
Protection against reverse voltages from the load
Parallel connection option
Depth x width x height
Net weight

92 %
> 0.95 @ 230 V AC
min. 20 ms
30...35 V DC
yes, max. 3
150 / 90 / 130 mm
2000 g

93%
> 0.95 @ 230 V AC
min. 20 ms
30...35 V DC
yes, max. 3
150 / 140 / 130 mm
3900 g

Approvals
Approvals

CE; cULus; cULusEX; cURus; EAC; GL; TUEV
--

CE; cULus; cULusEX; cURus; EAC; GL; TUEV
--

Connection data	
Connection system	
Number of terminals	
Wire cross-section, rigid min/max	mm ²
Wire cross-section, flexible min/max	mm ²
Wire cross-section, AWG/kcmil min/max	
Screwdriver blade	

Input	Output
Screw connection	Screw connection
3 for L/N/PE	8 (+,-,11,13,14)
0.18 / 6	0.18 / 6
0.22 / 4	0.22 / 4
26 / 10	26 / 10
0.8 x 4.0, PZ 1	0.8 x 4.0, PZ 1

Input	Output
Screw connection	Screw connection
3 for L/N/PE	8 (+,-,11,13,14)
0.18 / 6	0.5 / 16
0.22 / 4	0.5 / 16
26 / 10	22 / 8
0.8 x 4.0, PZ 1	1.0 x 5.5

Note

Ordering data

Type	Qty.	Order No.
PRO MAX 480W 24V 20A	1	1478140000

Type	Qty.	Order No.
PRO MAX 480W 24V 20A	1	1478140000

Type	Qty.	Order No.
PRO MAX 960W 24V 40A	1	1478150000

Note
The internal varistor found in a switch-mode power supply does not replace the need for surge protection within a system.

Note
The internal varistor found in a switch-mode power supply does not replace the need for surge protection within a system.

Note
The internal varistor found in a switch-mode power supply does not replace the need for surge protection within a system.

Accessories

Note

connectPower PROmax

connectPower PROmax

PRO MAX 70W 5V 14A

PRO MAX 72W 12V 6A

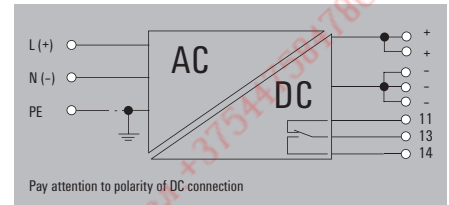
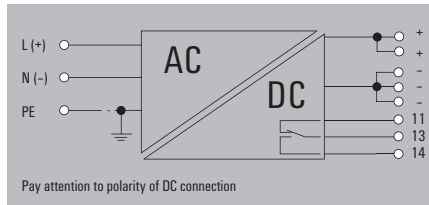

Technical data

Input	
Rated input voltage	100...240 V AC (wide-range input)
Input voltage range AC	85...277 V AC
Frequency range AC	45...65 Hz
DC input voltage range	80...370 V DC
AC current consumption	1 A @ 230 V AC / 1.5 A @ 115 V AC
DC current consumption	1 A @ 370 VDC / 1.5A @ 120 VDC
Input fuse (internal) / Inrush current	Yes / max. 15 A
Recommended back-up fuse	6 A, Char. B, circuit breaker, 3 - 5 A Char. C, circuit breaker

Rated input voltage	100...240 V AC (wide-range input)
Input voltage range AC	85...277 V AC
Frequency range AC	45...65 Hz
DC input voltage range	80...370 V DC
AC current consumption	1 A @ 230 V AC / 1.5 A @ 115 V AC
DC current consumption	1 A @ 370 VDC / 1.5A @ 120 VDC
Input fuse (internal) / Inrush current	Yes / max. 15 A
Recommended back-up fuse	6 A, Char. B, circuit breaker, 3 - 5 A Char. C, circuit breaker

Rated input voltage	100...240 V AC (wide-range input)
Input voltage range AC	85...277 V AC
Frequency range AC	45...65 Hz
DC input voltage range	80...370 V DC
AC current consumption	1 A @ 230 V AC / 1.5 A @ 115 V AC
DC current consumption	1 A @ 370 VDC / 1.5A @ 120 VDC
Input fuse (internal) / Inrush current	Yes / max. 15 A
Recommended back-up fuse	6 A, Char. B, circuit breaker, 3 - 5 A Char. C, circuit breaker

Output	
Rated output voltage	5 V DC
Output voltage	4.5...7 V (adjustable via potentiometer)
Residual ripple, breaking spikes	< 50 mVss @ U _{Nom} , Full Load
Rated (nominal) output current @ U _{Nom}	14 A @ 60°C
Continuous output current @ U _{Rated}	16,8 A @ 45°C, 10,5 A @ 70°C
Leitungsreserve @ U _{Rated}	16,8 A (1 min), 21 A (4s)
Pulsed current capacity @ U _{Rated}	42 A (2ms)

Rated output voltage	5 V DC
Output voltage	4.5...7 V (adjustable via potentiometer)
Residual ripple, breaking spikes	< 50 mVss @ U _{Nom} , Full Load
Rated (nominal) output current @ U _{Nom}	14 A @ 60°C
Continuous output current @ U _{Rated}	16,8 A @ 45°C, 10,5 A @ 70°C
Leitungsreserve @ U _{Rated}	16,8 A (1 min), 21 A (4s)
Pulsed current capacity @ U _{Rated}	42 A (2ms)

Rated output voltage	12 V DC ± 1 %
Output voltage	10...15 V (adjustable via potentiometer)
Residual ripple, breaking spikes	< 50 mVss @ U _{Nom} , Full Load
Rated (nominal) output current @ U _{Nom}	6 A @ 60°C
Continuous output current @ U _{Rated}	7.2 A @ 45°C, 4.5 A @ 70°C
Leitungsreserve @ U _{Rated}	7.2 A (1 min), 9 A (4s)
Pulsed current capacity @ U _{Rated}	18 A (2ms)

General data	
Degree of efficiency	86%
Power factor (approx.)	> 0.90 @ 230 V AC
AC failure bridging time @ I _{Nom}	min. 20 ms
Protection against reverse voltages from the load	> 7.5 V DC
Parallel connection option	yes, max. 5
Depth x width x height	125 / 32 / 130 mm
Net weight	650 g

Degree of efficiency	86%
Power factor (approx.)	> 0.90 @ 230 V AC
AC failure bridging time @ I _{Nom}	min. 20 ms
Protection against reverse voltages from the load	> 7.5 V DC
Parallel connection option	yes, max. 5
Depth x width x height	125 / 32 / 130 mm
Net weight	650 g

Degree of efficiency	89%
Power factor (approx.)	> 0.90 @ 230 V AC
AC failure bridging time @ I _{Nom}	min. 20 ms
Protection against reverse voltages from the load	> 18 V DC
Parallel connection option	yes, max. 5
Depth x width x height	125 / 32 / 130 mm
Net weight	650 g

Approvals CE; cULus; cULusEX; cURus; EAC; GL; TUEV

CE; cULus; cULusEX; cURus; EAC; GL; TUEV

CE; cULus; cULusEX; cURus; EAC; GL; TUEV

Connection data	
Connection system	Screw connection
Number of terminals	3 for L/N/PE
Wire cross-section, rigid min/max	0.18 / 6 mm ²
Wire cross-section, flexible min/max	0.22 / 4 mm ²
Wire cross-section, AWG/kcmil min/max	26 / 10
Screwdriver blade	0.8 x 4.0, PZ 1

Input	Output
Screw connection	Screw connection
3 for L/N/PE	8 (+, -, 11, 13, 14)
0.18 / 6	0.5 / 6
0.22 / 4	0.5 / 4
26 / 10	26 / 12
0.8 x 4.0, PZ 1	0.6 x 3.5

Input	Output
Screw connection	Screw connection
3 for L/N/PE	8 (+, -, 11, 13, 14)
0.18 / 6	0.5 / 6
0.22 / 4	0.5 / 4
26 / 10	26 / 12
0.8 x 4.0, PZ 1	0.6 x 3.5

Ordering data

Type	Qty.	Order No.
PRO MAX 70W 5V 14A	1	1478210000

Type	Qty.	Order No.
PRO MAX 70W 5V 14A	1	1478210000

Type	Qty.	Order No.
PRO MAX 72W 12V 6A	1	1478220000

Note The internal varistor found in a switch-mode power supply does not replace the need for surge protection within a system.

The internal varistor found in a switch-mode power supply does not replace the need for surge protection within a system.

The internal varistor found in a switch-mode power supply does not replace the need for surge protection within a system.

Accessories

Note

Note

Note

connectPower PROmax

PRO MAX 120W 12V 10A

PRO MAX 240W 48V 5A

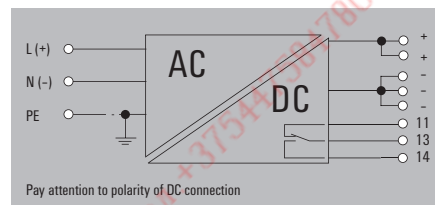
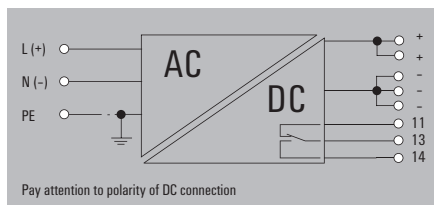

Technical data

Input	
Rated input voltage	100...240 V AC (wide-range input)
Input voltage range AC	85...277 V AC
Frequency range AC	45...65 Hz
DC input voltage range	80...370 V DC
AC current consumption	1A @ 230 VAC / 2,5A @ 115 VAC
DC current consumption	1,5A @ 370 VDC / 2,5A @ 120 VDC
Input fuse (internal) / Inrush current	Yes / max. 15 A
Recommended back-up fuse	6 A, Char. B, circuit breaker, 6 A, char. C circuit breaker

Output	
Rated output voltage	12 V DC ± 1 %
Output voltage	10...15 V (adjustable via potentiometer)
Residual ripple, breaking spikes	< 50 mVss @ U _{Nom} , Full Load
Rated (nominal) output current @ U _{Nom}	10 A @ 60 °C
Continuous output current @ U _{Rated}	12 A @ 45°C, 7,5 A @ 70°C
Leitungsreserve @ U _{Rated}	12 A (1 min), 15 A (4s)
Pulsed current capacity @ U _{Rated}	30 A (2ms)

General data	
Degree of efficiency	89%
Power factor (approx.)	> 0.90 @ 230 V AC
AC failure bridging time @ I _{Nom}	min. 20 ms
Protection against reverse voltages from the load	> 18 V DC
Parallel connection option	yes, max. 5
Depth x width x height	125 / 40 / 130 mm
Net weight	850 g

Approvals	
Approvals	CE; cULus; cULusEX; cURus; EAC; GL; TUEV

Connection data	
Connection system	Screw connection
Number of terminals	3 for L/N/PE
Wire cross-section, rigid min/max	0.18 / 6 mm ²
Wire cross-section, flexible min/max	0.22 / 4 mm ²
Wire cross-section, AWG/kcmil min/max	26 / 10
Screwdriver blade	0.8 x 4.0, PZ 1

Note	
Note	

Ordering data

Type	Qty.	Order No.
PRO MAX 120W 12V 10A	1	1478230000

Note	
Note	The internal varistor found in a switch-mode power supply does not replace the need for surge protection within a system.

Accessories

Note	
Note	

Input	
Rated input voltage	100...240 V AC (wide-range input)
Input voltage range AC	85...277 V AC
Frequency range AC	45...65 Hz
DC input voltage range	80...370 V DC
AC current consumption	1A @ 230 VAC / 2,5A @ 115 VAC
DC current consumption	1,5A @ 370 VDC / 2,5A @ 120 VDC
Input fuse (internal) / Inrush current	Yes / max. 15 A
Recommended back-up fuse	6 A, Char. B, circuit breaker, 6 A, char. C circuit breaker

Output	
Rated output voltage	48 V DC ± 1 %
Output voltage	30...56 V (adjustable via potentiometer)
Residual ripple, breaking spikes	< 50 mVss @ U _{Nom} , Full Load
Rated (nominal) output current @ U _{Nom}	5 A @ 60 °C
Continuous output current @ U _{Rated}	6.0 A @ 45 °C, 3,75 A @ 70 °C
Leitungsreserve @ U _{Rated}	5 A (1 min), 7,5 A (4s)
Pulsed current capacity @ U _{Rated}	15 A (2ms)

General data	
Degree of efficiency	92.5%
Power factor (approx.)	> 0.95 @ 230 V AC
AC failure bridging time @ I _{Nom}	min. 20 ms
Protection against reverse voltages from the load	58 ... 65 V DC
Parallel connection option	yes, max. 5
Depth x width x height	125 / 60 / 130 mm
Net weight	1050 g

Approvals	
Approvals	CE; cULus; cULusEX; cURus; EAC; GL; TUEV

Connection data	
Connection system	Screw connection
Number of terminals	8 (++, --, 11, 13, 14)
Wire cross-section, rigid min/max	0.18 / 6
Wire cross-section, flexible min/max	0.22 / 4
Wire cross-section, AWG/kcmil min/max	26 / 10
Screwdriver blade	0.8 x 4.0, PZ 1

Note	
Note	

Type	Qty.	Order No.
PRO MAX 240W 48V 5A	1	1478240000

Note	
Note	The internal varistor found in a switch-mode power supply does not replace the need for surge protection within a system.

connectPower PROmax

connectPower PROmax

PRO MAX 480W 48V 10A

PRO MAX 960W 48V 20A

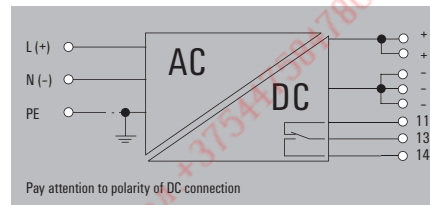
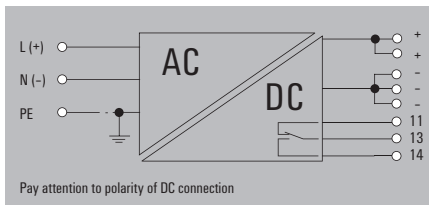

Technical data

Input	
Rated input voltage	100...240 V AC (wide-range input)
Input voltage range AC	85...277 V AC
Frequency range AC	45...65 Hz
DC input voltage range	80...370 V DC
AC current consumption	2,3A @ 230 VAC / 4,8A @ 115 VAC
DC current consumption	1,5A @ 370 VDC / 4,8A @ 120 VDC
Input fuse (internal) / Inrush current	Yes / max. 15 A
Recommended back-up fuse	16 A, Char. B circuit breaker, 10 A, char. C circuit breaker

Output	
Rated output voltage	48 V DC ± 1 %
Output voltage	30...56 V (adjustable via potentiometer)
Residual ripple, breaking spikes	< 50 mVss @ U _{Nom} , Full Load
Rated (nominal) output current @ U _{Nom}	10 A @ 60 °C
Continuous output current @ U _{Rated}	12 A @ 45°C, 7,5 A @ 70°C
Leitungsreserve @ U _{Rated}	12 A (1 min), 15 A (4s), 100...240 V AC
Pulsed current capacity @ U _{Rated}	60 A (2ms)

General data	
Degree of efficiency	93%
Power factor (approx.)	> 0.95 @ 230 V AC
AC failure bridging time @ I _{Nom}	min. 20 ms
Protection against reverse voltages from the load	58 ... 65 V DC
Parallel connection option	yes, max. 5
Depth x width x height	150 / 90 / 130 mm
Net weight	2000 g

Approvals	
Approvals	CE; cULus; cULusEX; cURus; EAC; GL; TUEV

Connection data	
Connection system	Screw connection
Number of terminals	3 for L/N/PE
Wire cross-section, rigid min/max	0.18 / 6 mm ²
Wire cross-section, flexible min/max	0.22 / 4 mm ²
Wire cross-section, AWG/kcmil min/max	26 / 10
Screwdriver blade	0.8 x 4.0, PZ 1

Note	

Ordering data

Type	Qty.	Order No.
PRO MAX 480W 48V 10A	1	1478250000

Note	

Accessories

Note	

Input	
Rated input voltage	100...240 V AC (wide-range input)
Input voltage range AC	85...277 V AC
Frequency range AC	45...65 Hz
DC input voltage range	80...370 V DC
AC current consumption	2,3A @ 230 VAC / 4,8A @ 115 VAC
DC current consumption	1,5A @ 370 VDC / 4,8A @ 120 VDC
Input fuse (internal) / Inrush current	Yes / max. 15 A
Recommended back-up fuse	16 A, Char. B circuit breaker, 10 A, char. C circuit breaker

Output	
Rated output voltage	48 V DC ± 1 %
Output voltage	30...56 V (adjustable via potentiometer)
Residual ripple, breaking spikes	< 50 mVss @ U _{Nom} , Full Load
Rated (nominal) output current @ U _{Nom}	10 A @ 60 °C
Continuous output current @ U _{Rated}	12 A @ 45°C, 7,5 A @ 70°C
Leitungsreserve @ U _{Rated}	12 A (1 min), 15 A (4s), 100...240 V AC
Pulsed current capacity @ U _{Rated}	60 A (2ms)

General data	
Degree of efficiency	93%
Power factor (approx.)	> 0.95 @ 230 V AC
AC failure bridging time @ I _{Nom}	min. 20 ms
Protection against reverse voltages from the load	58 ... 65 V DC
Parallel connection option	yes, max. 5
Depth x width x height	150 / 90 / 130 mm
Net weight	2000 g

Approvals	
Approvals	CE; cULus; cULusEX; cURus; EAC; GL; TUEV

Connection data	
Connection system	Screw connection
Number of terminals	3 for L/N/PE
Wire cross-section, rigid min/max	0.18 / 6 mm ²
Wire cross-section, flexible min/max	0.22 / 4 mm ²
Wire cross-section, AWG/kcmil min/max	26 / 10
Screwdriver blade	0.8 x 4.0, PZ 1

Note	

Type	Qty.	Order No.
PRO MAX 480W 48V 10A	1	1478250000

Note	
The internal varistor found in a switch-mode power supply does not replace the need for surge protection within a system.	

Input	
Rated input voltage	100...240 V AC (wide-range input)
Input voltage range AC	85...277 V AC
Frequency range AC	45...65 Hz
DC input voltage range	80...370 V DC
AC current consumption	4,52A @ 230 VAC / 10A @ 115 VAC
DC current consumption	2,8A @ 370 VDC / 10A @ 120 VDC
Input fuse (internal) / Inrush current	Yes / max. 15 A
Recommended back-up fuse	20 A, char. B circuit breaker, 16 A, Char. C circuit breaker

Output	
Rated output voltage	48 V DC ± 1 %
Output voltage	30...56 V (adjustable via potentiometer)
Residual ripple, breaking spikes	< 50 mVss @ U _{Nom} , Full Load
Rated (nominal) output current @ U _{Nom}	20 A @ 60 °C
Continuous output current @ U _{Rated}	24 A @ 45°C, 15 A @ 70°C
Leitungsreserve @ U _{Rated}	24 A (1 min), 30 A (4s), 100...240 V AC
Pulsed current capacity @ U _{Rated}	60 A (2ms)

General data	
Degree of efficiency	94%
Power factor (approx.)	> 0.95 @ 230 V AC
AC failure bridging time @ I _{Nom}	min. 20 ms
Protection against reverse voltages from the load	58 ... 65 V DC
Parallel connection option	yes, max. 5
Depth x width x height	150 / 140 / 130 mm
Net weight	1350 g

Approvals	
Approvals	CE; cULus; cULusEX; cURus; EAC; GL; TUEV

Connection data	
Connection system	Screw connection
Number of terminals	3 for L/N/PE
Wire cross-section, rigid min/max	0.18 / 6 mm ²
Wire cross-section, flexible min/max	0.22 / 4 mm ²
Wire cross-section, AWG/kcmil min/max	26 / 10
Screwdriver blade	0.8 x 4.0, PZ 1

Note	

Type	Qty.	Order No.
PRO MAX 960W 48V 20A	1	1478270000

Note	
The internal varistor found in a switch-mode power supply does not replace the need for surge protection within a system.	

connectPower PROmax

PRO MAX3 120W 24V 5A

PRO MAX3 240W 24V 10A

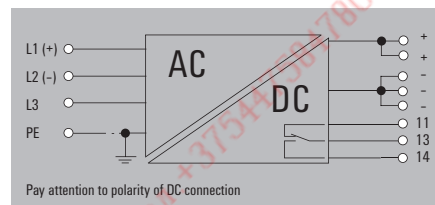
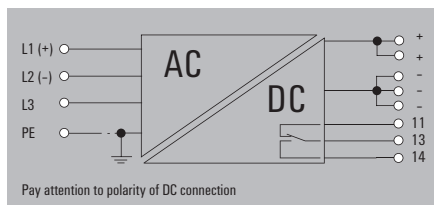

Technical data

Input	
Rated input voltage	3 x 400...3 x 500 V AC (wide-range input)
Input voltage range AC	3 x 320...3 x 575 V AC / 2 x 360...2 x 575 V AC
Frequency range AC	45...65 Hz
DC input voltage range	450...800 V DC (max. 500 V DC acc. to UL508)
AC current consumption	0,28A @ 3*500 VAC / 0,3A @ 3*400 VAC
DC current consumption	0.18 A @ 800 V DC / 0.3 A @ 450 V DC
Input fuse (internal) / Inrush current	Yes / max. 15 A
Recommended back-up fuse	2...3 A, char. C circuit breaker

Output	
Rated output voltage	24 V DC ± 1 %
Output voltage	22.5...29.5 V (adjustable via potentiometer)
Residual ripple, breaking spikes	< 50 mVss @ U _{Nom} , Full Load
Rated (nominal) output current @ U _{Nom}	5 A @ 60 °C
Continuous output current @ U _{Rated}	6.0 A @ 45 °C, 3.75 A @ 70 °C
Leitungsreserve @ U _{Rated}	6 A (1 min), 7.5 A (4s), 400...500 V AC
Pulsed current capacity @ U _{Rated}	15 A (2ms)

General data	
Degree of efficiency	90%
Power factor (approx.)	> 0.50 @ 3*400 V AC
AC failure bridging time @ I _{Nom}	min. 20 ms
Protection against reverse voltages from the load	30...35 V DC
Parallel connection option	yes, max. 5
Depth x width x height	125 / 40 / 130 mm
Net weight	783 g

Approvals	
Approvals	CE; cULus; cULusEX; cURus; EAC; GL; TUEV

Connection data	
Connection system	Screw connection
Number of terminals	4 for L1/L2/L3/PE
Wire cross-section, rigid min/max	0.18 / 6 mm ²
Wire cross-section, flexible min/max	0.22 / 4 mm ²
Wire cross-section, AWG/kcmil min/max	26 / 10
Screwdriver blade	0.8 x 4.0, PZ 1

Note	

Ordering data

Type	Qty.	Order No.
PRO MAX3 120W 24V 5A	1	1478170000

Note	
The internal varistor found in a switch-mode power supply does not replace the need for surge protection within a system.	

Accessories

Note	

Input	
Rated input voltage	3 x 400...3 x 500 V AC (wide-range input)
Input voltage range AC	3 x 320...3 x 575 V AC / 2 x 360...2 x 575 V AC
Frequency range AC	45...65 Hz
DC input voltage range	450...800 V DC (max. 500 V DC acc. to UL508)
AC current consumption	0,28A @ 3*500 VAC / 0,3A @ 3*400 VAC
DC current consumption	0.18 A @ 800 V DC / 0.3 A @ 450 V DC
Input fuse (internal) / Inrush current	Yes / max. 15 A
Recommended back-up fuse	2...3 A, char. C circuit breaker

Output	
Rated output voltage	24 V DC ± 1 %
Output voltage	22.5...29.5 V (adjustable via potentiometer)
Residual ripple, breaking spikes	< 50 mVss @ U _{Nom} , Full Load
Rated (nominal) output current @ U _{Nom}	5 A @ 60 °C
Continuous output current @ U _{Rated}	6.0 A @ 45 °C, 3.75 A @ 70 °C
Leitungsreserve @ U _{Rated}	6 A (1 min), 7.5 A (4s), 400...500 V AC
Pulsed current capacity @ U _{Rated}	15 A (2ms)

General data	
Degree of efficiency	90%
Power factor (approx.)	> 0.50 @ 3*400 V AC
AC failure bridging time @ I _{Nom}	min. 20 ms
Protection against reverse voltages from the load	30...35 V DC
Parallel connection option	yes, max. 5
Depth x width x height	125 / 40 / 130 mm
Net weight	783 g

Approvals	
Approvals	CE; cULus; cULusEX; cURus; EAC; GL; TUEV

Connection data	
Connection system	Screw connection
Number of terminals	4 for L1/L2/L3/PE
Wire cross-section, rigid min/max	0.18 / 6 mm ²
Wire cross-section, flexible min/max	0.22 / 4 mm ²
Wire cross-section, AWG/kcmil min/max	26 / 10
Screwdriver blade	0.8 x 4.0, PZ 1

Note	

Type	Qty.	Order No.
PRO MAX3 120W 24V 5A	1	1478170000

Note	
The internal varistor found in a switch-mode power supply does not replace the need for surge protection within a system.	

Input	
Rated input voltage	3 x 400...3 x 500 V AC (wide-range input)
Input voltage range AC	3 x 320...3 x 575 V AC / 2 x 360...2 x 575 V AC
Frequency range AC	45...65 Hz
DC input voltage range	450...800 V DC (max. 500 V DC acc. to UL508)
AC current consumption	0,35A @ 3*500 VAC / 0,4A @ 3*400 VAC
DC current consumption	0.35 A @ 800 V DC / 0.6 A @ 450 V DC
Input fuse (internal) / Inrush current	Yes / max. 15 A
Recommended back-up fuse	3 - 5 A Char. C, circuit breaker

Output	
Rated output voltage	24 V DC ± 1 %
Output voltage	22.5...29.5 V (adjustable via potentiometer)
Residual ripple, breaking spikes	< 50 mVss @ U _{Nom} , Full Load
Rated (nominal) output current @ U _{Nom}	10 A @ 60 °C
Continuous output current @ U _{Rated}	12 A @ 45°C, 7.5 A @ 70°C
Leitungsreserve @ U _{Rated}	12 A (1 min), 15 A (4s)
Pulsed current capacity @ U _{Rated}	30 A (2ms)

General data	
Degree of efficiency	91.5%
Power factor (approx.)	> 0.85 @ 3*400 V AC
AC failure bridging time @ I _{Nom}	min. 20 ms
Protection against reverse voltages from the load	30...35 V DC
Parallel connection option	yes, max. 5
Depth x width x height	125 / 60 / 130 mm
Net weight	1322 g

Approvals	
Approvals	CE; cULus; cULusEX; cURus; EAC; GL; TUEV

Connection data	
Connection system	Screw connection
Number of terminals	4 for L1/L2/L3/PE
Wire cross-section, rigid min/max	0.18 / 6 mm ²
Wire cross-section, flexible min/max	0.22 / 4 mm ²
Wire cross-section, AWG/kcmil min/max	26 / 10
Screwdriver blade	0.8 x 4.0, PZ 1

Note	

Type	Qty.	Order No.
PRO MAX3 240W 24V 10A	1	1478180000

Note	
The internal varistor found in a switch-mode power supply does not replace the need for surge protection within a system.	

connectPower PROmax

connectPower PROmax

PRO MAX3 480W 24V 20A

PRO MAX3 960W 24V 40A

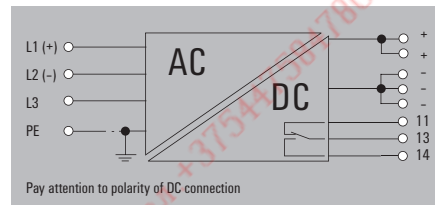
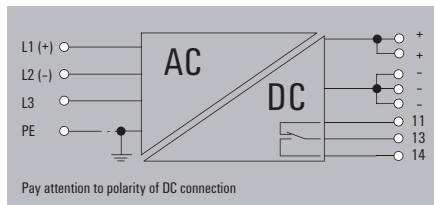

Technical data

Input	
Rated input voltage	3 x 400...3 x 500 V AC (wide-range input)
Input voltage range AC	3 x 320...3 x 575 V AC / 2 x 360...2 x 575 V AC
Frequency range AC	45...65 Hz
DC input voltage range	450...800 V DC (max. 500 V DC acc. to UL508)
AC current consumption	0,7A @ 3*500 VAC / 0,85 @ 3*400 VAC
DC current consumption	0,7 A @ 800 V DC / 1,2 A @ 450 V DC
Input fuse (internal) / Inrush current	Yes / max. 15 A
Recommended back-up fuse	3 - 5 A Char. C, circuit breaker

Output	
Rated output voltage	24 V DC ± 1 %
Output voltage	22.5...29.5 V (adjustable via potentiometer)
Residual ripple, breaking spikes	< 50 mVss @ U _{Nom} , Full Load
Rated (nominal) output current @ U _{Nom}	20 A @ 60 °C
Continuous output current @ U _{Rated}	24 A @ 45°C, 15 A @ 70°C
Leitungsreserve @ U _{Rated}	24 A (1 min), 30 A (4s)
Pulsed current capacity @ U _{Rated}	60 A (2ms)

General data	
Degree of efficiency	91.5%
Power factor (approx.)	> 0.85 @ 3*400 V AC
AC failure bridging time @ I _{Nom}	min. 20 ms
Protection against reverse voltages from the load	30...35 V DC
Parallel connection option	yes, max. 3
Depth x width x height	150 / 70 / 130 mm
Net weight	1600 g

Approvals	
Approvals	CE; cULus; cULusEX; cURus; EAC; GL; TUEV

Connection data	
Connection system	Screw connection
Number of terminals	4 for L1/L2/L3/PE
Wire cross-section, rigid min/max	0.18 / 6 mm ²
Wire cross-section, flexible min/max	0.22 / 4 mm ²
Wire cross-section, AWG/kcmil min/max	26 / 10
Screwdriver blade	0.8 x 4.0, PZ 1

Note	

Ordering data

Type	Qty.	Order No.
PRO MAX3 480W 24V 20A	1	1478190000

Note	

Accessories

Note	

Input	
Rated input voltage	3 x 400...3 x 500 V AC (wide-range input)
Input voltage range AC	3 x 320...3 x 575 V AC / 2 x 360...2 x 575 V AC
Frequency range AC	45...65 Hz
DC input voltage range	450...800 V DC (max. 500 V DC acc. to UL508)
AC current consumption	0,7A @ 3*500 VAC / 0,85 @ 3*400 VAC
DC current consumption	0,7 A @ 800 V DC / 1,2 A @ 450 V DC
Input fuse (internal) / Inrush current	Yes / max. 15 A
Recommended back-up fuse	3 - 5 A Char. C, circuit breaker

Output	
Rated output voltage	24 V DC ± 1 %
Output voltage	22.5...29.5 V (adjustable via potentiometer)
Residual ripple, breaking spikes	< 50 mVss @ U _{Nom} , Full Load
Rated (nominal) output current @ U _{Nom}	20 A @ 60 °C
Continuous output current @ U _{Rated}	24 A @ 45°C, 15 A @ 70°C
Leitungsreserve @ U _{Rated}	24 A (1 min), 30 A (4s)
Pulsed current capacity @ U _{Rated}	60 A (2ms)

General data	
Degree of efficiency	91.5%
Power factor (approx.)	> 0.85 @ 3*400 V AC
AC failure bridging time @ I _{Nom}	min. 20 ms
Protection against reverse voltages from the load	30...35 V DC
Parallel connection option	yes, max. 3
Depth x width x height	150 / 70 / 130 mm
Net weight	1600 g

Approvals	
Approvals	CE; cULus; cULusEX; cURus; EAC; GL; TUEV

Input		Output	
Connection system	Screw connection	Connection system	Screw connection
Number of terminals	4 for L1/L2/L3/PE	Number of terminals	8 (++, --, 11, 13, 14)
Wire cross-section, rigid min/max	0.18 / 6	Wire cross-section, rigid min/max	0.18 / 6
Wire cross-section, flexible min/max	0.22 / 4	Wire cross-section, flexible min/max	0.22 / 4
Wire cross-section, AWG/kcmil min/max	26 / 10	Wire cross-section, AWG/kcmil min/max	26 / 10
Screwdriver blade	0.8 x 4.0, PZ 1	Screwdriver blade	0.8 x 4.0, PZ 1

Note	

Type	Qty.	Order No.
PRO MAX3 480W 24V 20A	1	1478190000

Note	
The internal varistor found in a switch-mode power supply does not replace the need for surge protection within a system.	

Input	
Rated input voltage	3 x 400...3 x 500 V AC (wide-range input)
Input voltage range AC	3 x 320...3 x 575 V AC / 2 x 360...2 x 575 V AC
Frequency range AC	45...65 Hz
DC input voltage range	450...800 V DC (max. 500 V DC acc. to UL508)
AC current consumption	1,3A @ 3*500 VAC / 1,6A @ 3*400 VAC
DC current consumption	1,4 A @ 800 V DC / 2,4 A @ 450 V DC
Input fuse (internal) / Inrush current	Yes / max. 15 A
Recommended back-up fuse	6...8 A, char. C circuit breaker

Output	
Rated output voltage	24 V DC ± 1 %
Output voltage	22.5...29.5 V (adjustable via potentiometer)
Residual ripple, breaking spikes	< 50 mVss @ U _{Nom} , Full Load
Rated (nominal) output current @ U _{Nom}	40 A @ 60 °C
Continuous output current @ U _{Rated}	48 A @ 45°C, 30 A @ 70°C
Leitungsreserve @ U _{Rated}	48 A (1 min), 60 A (4s), 400...500 V AC
Pulsed current capacity @ U _{Rated}	120 A (2ms)

General data	
Degree of efficiency	93.5%
Power factor (approx.)	> 0.75 @ 3*400 V AC
AC failure bridging time @ I _{Nom}	min. 20 ms
Protection against reverse voltages from the load	30...35 V DC
Parallel connection option	yes, max. 3
Depth x width x height	150 / 140 / 130 mm
Net weight	3400 g

Approvals	
Approvals	CE; cULus; cULusEX; cURus; EAC; GL; TUEV

Input		Output	
Connection system	Screw connection	Connection system	Screw connection
Number of terminals	4 for L1/L2/L3/PE	Number of terminals	8 (++, --, 11, 13, 14)
Wire cross-section, rigid min/max	0.18 / 6	Wire cross-section, rigid min/max	0.5 / 16
Wire cross-section, flexible min/max	0.22 / 4	Wire cross-section, flexible min/max	0.5 / 16
Wire cross-section, AWG/kcmil min/max	26 / 10	Wire cross-section, AWG/kcmil min/max	22 / 8
Screwdriver blade	0.8 x 4.0, PZ 1	Screwdriver blade	1.0 x 5.5

Note	

Type	Qty.	Order No.
PRO MAX3 960W 24V 40A	1	1478200000

Note	
The internal varistor found in a switch-mode power supply does not replace the need for surge protection within a system.	

connectPower PROmax redundancy module



PRO RM 10

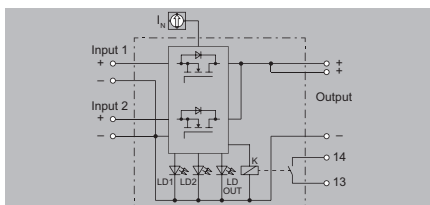

PRO RM 20

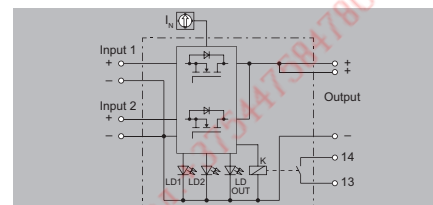

Technical data

Input
DC input voltage range
DC current consumption
Output
Rated output voltage
Continuous output current @ U_{Rated}
General data
Ambient temperature (operational)
Storage temperature
Derating
Degree of efficiency
Mounting position, installation notice
Depth x width x height / Net weight
Approvals

10 ... 32 V DC
2 × 12 A (-40 °C ~ +45 °C), 2 × 10 A (+45 °C ~ +60 °C), 2 × 7.5 A (+70 °C)
UNDEFINED TEXT
1 × 24 A (-40 °C ~ +45 °C), 1 × 20 A (+45 °C ~ +60 °C), 1 × 15 A (+70 °C)
-40 °C...70 °C
85 °C...40 °C
> 60°C / 75% @ 70°C
> 98%
Horizontal on TS35 mounting rail. 50 mm of clearance at top & bottom for air circ. Can mount side by side with no space in between.
125 / 30 / 130 mm / 497 g

10 ... 32 V DC
2 × 24 A (-40 °C ~ +45 °C), 2 × 20 A (+45 °C ~ +60 °C), 2 × 15 A (+70 °C)
UNDEFINED TEXT
1 × 48 A (-40 °C ~ +45 °C), 1 × 40 A (+45 °C ~ +60 °C), 1 × 30 A (+70 °C)
-40 °C...70 °C
85 °C...40 °C
> 60°C / 75% @ 70°C
> 98%
Horizontal on TS35 mounting rail. 50 mm of clearance at top & bottom for air circ. Can mount side by side with no space in between.
125 / 38 / 130 mm / 558 g

Connection data	
Connection system	
Number of terminals	
Wire cross-section, rigid min/max	mm ²
Wire cross-section, flexible min/max	mm ²
Wire cross-section, AWG/kcmil min/max	
Tightening torque range	

Input	Output
PUSH IN	PUSH IN
4 (+, +, -, -)	2 (+ / -)
0.2 / 2.5	0.2 / 10
0.2 / 2.5	0.2 / 6
26 / 12	24 / 8

Input	Output
PUSH IN	PUSH IN
4 (+, +, -, -)	2 (+ / -)
0.2 / 10	0.75 / 16
0.2 / 6	0.75 / 16
24 / 8	20 / 4

Note

Ordering data

Screw connection

Type	Qty.	Order No.
PRO RM 10	1	2486090000

Type	Qty.	Order No.
PRO RM 20	1	2486100000

Note

connectPower PROmax

connectPower PROmax redundancy module

PRO RM 40

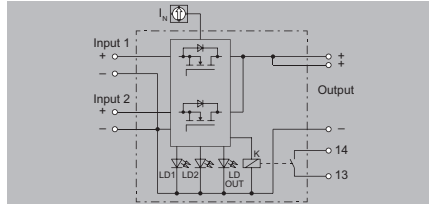

Technical data

Input	
DC input voltage range	10 ... 32 V DC
DC current consumption	2 × 48 A (-40 °C ~ +45 °C), 2 × 40 A (+45 °C ~ +60 °C), 2 × 30 A (+70 °C)
Output	
Rated output voltage	*UNDEFINED TEXT*
Continuous output current @ U _{Rated}	1 × 96 A (-40 °C ~ +45 °C), 1 × 80 A (+45 °C ~ +60 °C), 1 × 60 A (+70 °C)
General data	
Ambient temperature (operational)	-40 °C...70 °C
Storage temperature	85 °C...-40 °C
Derating	> 60°C / 75% @ 70°C
Degree of efficiency	> 98%
Mounting position, installation notice	Horizontal on TS35 mounting rail. 50 mm of clearance at top & bottom for air circ. Can mount side by side with no space in between.
Depth x width x height / Net weight	125 / 52 / 130 mm / 747 g
Approvals	

Connection data		Input	Output
Connection system		Screw connection	Screw connection
Number of terminals		4 (+, +, -, -)	2 (+ / -)
Wire cross-section, rigid min/max	mm ²	0.2 / 16	0.5 / 16
Wire cross-section, flexible min/max	mm ²	0.5 / 16	0.5 / 35
Wire cross-section, AWG/kcmil min/max		22 / 6	20 / 1
Tightening torque range			/ 4

Note	

Ordering data

Type	Qty.	Order No.
PRO RM 40	1	2486110000

Screw connection

Note	

PRO-M: diode, capacitor and relay modules



CP M CAP



Pulse triggering for circuit breakers: with the Weidmüller capacitance module

The following conditions apply to the table entries:

- Ambient temperature of 20 °C
- Inner resistance of the circuit breakers is taken into account
- Half of the rated current flows to a neighbouring circuit before the short circuit is formed
- DC-compatible circuit breakers: Siemens 5SY series

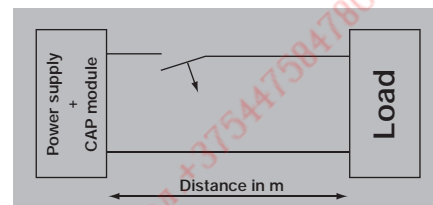
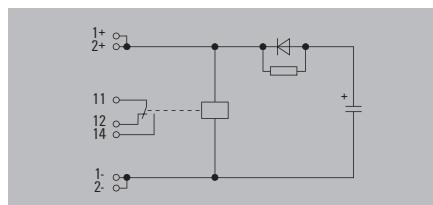

Technical data

Input	
Rated input voltage / DC input voltage range	24 V DC / 18...30 V DC
Output	
Peak current output / Recovery time for the capacitor	Depending on the load (typically 40 A for 1 ms) / Approx. 1 sec.
Switching thresholds	21.6 V DC, relay is on for Power Good, 20.4 V DC, relay is off for Power Fail
Floating contact	Yes
General data	
Depth x width x height / Net weight	/ 150 / 34 / 130 mm / 733 g
Ambient temperature (operational) / Storage temperature	-25 °C...70 °C/40 °C...85 °C
Humidity	5...95 %, no condensation
Protection degree	IP20
Class of protection	III, with no ground connection, for SELV
Pollution degree	2
Insulation voltage	0.5 kV <small>Input/output housing</small>
MTBF	> 500,000 h acc. to IEC 1709 (SN29500)
Mounting position, installation notice	Horizontal on TS35 mounting rail. 50 mm of clearance at top & bottom for air circ. Can mount side by side with no space in between.
EMC / shock / vibration	
Noise emission acc. to EN55022	Class B
Interference immunity test acc. to	EN 61000-4-2 (ESD) EN 61000-4-3 and EN 61000-4-8 (fields) EN 61000-4-4 (burst) EN 61000-4-5 (surge) EN 61000-4-6 (conducted) EN 61000-4-11 (dips)
Resistance to vibration / Shock	1 g according to EN50178 / 15 g ln all directions
Electrical safety (applied standards)	
Electrical machine equipment	Acc. to EN60204
For use with electronic equipment	Acc. to EN50178 / VDE0160
Safety extra-low voltage	SELV acc. to EN60950, PELV acc. to EN60204
Approvals	
Approvals	CE; cULus; EAC; GL
Connection data	
Wire connection method	Screw connection
Number of terminals	4 (++-)
Wire cross-section, rigid min/max	0.5 / 6
Wire cross-section, flexible min/max	0.5 / 4
Wire cross-section, AWG/kcmil min/max	26 / 12
Note	For low-impedance connections we recommend 2.5 mm ² .

Input	Output
Wire connection method	Screw connection
Number of terminals	3 (CO contacts)
Wire cross-section, rigid min/max	0.5 / 6
Wire cross-section, flexible min/max	0.5 / 2.5
Wire cross-section, AWG/kcmil min/max	26 / 12
Note	For low-impedance connections we recommend 2.5 mm ² .

Fuse tripping

Conductor cross section	B6	B10
0.75 mm ²	10 m	
1.0 mm ²	14 m	6 m
1.5 mm ²	20 m	9 m
2.5 mm ²	30 m	15 m
4 mm ²	50 m	24 m
6 mm ²		
B16		
0.75 mm ²		
1.0 mm ²		
1.5 mm ²	4 m	
2.5 mm ²	6 m	
4 mm ²	10 m	
6 mm ²	16 m	
C2 C4		
0.75 mm ²	11 m	6 m
1.0 mm ²	14 m	8 m
1.5 mm ²	21 m	12 m
2.5 mm ²	34 m	19 m
4 mm ²		32 m
6 mm ²		
C6 C10		
0.75 mm ²	3 m	
1.0 mm ²	3.5 m	2 m
1.5 mm ²	5.5 m	3 m
2.5 mm ²	9 m	5 m
4 mm ²	14 m	8 m
6 mm ²		12 m

Ordering data

	Plastic clip-in foot
	Metal clip-in foot

Type	Qty.	Order No.
CP M CAP	1	1222240000
CP M CAP	1	1222240010

Note

Accessories

Note

**PRO-M: Application solution for wind power
Switched-mode power supply with wide-range
input**

Application solution for wind power:

- 80 ... 430 V DC input
- Alarm contact
- Metal snap-on foot

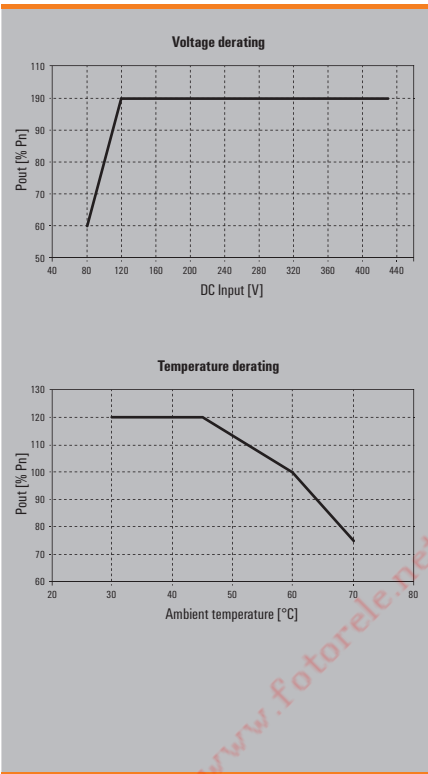

Technical data

General technical data	
Output characteristic curve / current limit	I _U / > 120 % I _n
Earth discharge current	< 3.5 mA
Ambient temperature (operational) / Storage temperature / Start-up	-25 °C...+70 °C / -40 °C...+85 °C / ≥ -40 °C
Max. permitted humidity (operational)	5 %...95 % RH
Degree of protection	IP 20
Class of protection	I, with PE connection
Pollution degree	2
Insulation voltage	3 kV AC 1 min. / 2 kV AC 1 min. / 0.5 kV AC 1 min.
MTBF	> 500,000 h according to IEC 1709 (SN29500)
Protection against reverse voltages from the load	30...35 V DC
Can be connected in parallel	Yes, without diode module
Housing version	Metal, corrosion resistant
Signal indication	Operations, green/red LED
Mounting position, installation notice	Horizontal on TS 35 mounting rail, with 50 mm of clearance at top and bottom for air circulation. Can be mounted side by side with no space in between. Suitable for installation in rotating systems.
EMC / shock / vibration	
Noise emission acc. to EN55022	Class B
Noise immunity tests acc. to	EN61000-4-2 (ESD), EN61000-4-3 and EN61000-4-8 (Fields), EN61000-4-4 (Burst), EN61000-4-5 (Surge), EN61000-4-6 (conducted), EN61000-4-11 (Dips)
Limiting of mains voltage harmonic currents	according to EN61000-3-2
Resistance against vibration and shock	according to EN50178, Shock: 5 g in all directions
Electrical safety (applied standards)	
Electrical equipment of machines	according to EN60204
Safety transformers for switched-mode power units	according to EN61558-2-16
Safety transformers for switched-mode power units	according to EN50178 / VDE0160
Safety extra low voltage	SELV according to EN60950, PELV according to EN60204
Protective separation / protection against electrical shock	VDE0100-410 / according to DIN57100-410
Protection against dangerous shock currents	according to VDE0106-101

PRO-M: application solutions for wind energy

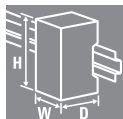

CP M SNT 250W 24V 10A UW

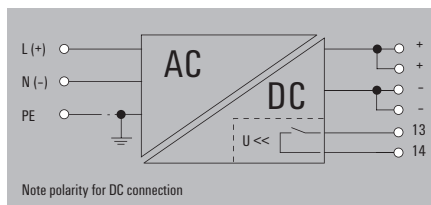

Technical data

Input	
Rated input voltage / Input voltage range AC	
Frequency range AC	
DC input voltage range	
AC current consumption	
DC current consumption	
Input fuse (internal)	
Recommended back-up fuse	
Output	
Rated output voltage	
Output voltage	
Residual ripple, breaking spikes	
Rated (nominal) output current @ U_{nom}	
Continuous output current	
General data	
Degree of efficiency	
Power factor (approx.)	
AC failure bridging time @ I_{nom}	
Depth x width x height / Net weight	
Additional equipment	
Status indicator	
Relay on/off	
Approvals	
Approvals	

100...240 V AC (wide-range input) / 85...264 V AC (Derating @ 100 V AC)
47...63 Hz
80...430 V DC
1.2 A @ 230 V AC / 2.4 A @ 115 V AC
0.8 A @ 370 V DC / 2.3 A @ 120 V DC
Yes
4 A / DI, safety fuse
10 A, Char. B, circuit breaker
3...4 A, Char. C, circuit breaker
24 V DC \pm 1 %
22.5...29.5 V DC (adjustable via potentiometer on front)
< 50 mV _{SS} @ 24 V DC, I_N < 2.4 V _{SS} @ 24 V DC, I_N @ -40°C
10 A @ 60 °C
90 % @ 230 V AC / 87 % @ 115 V AC
> 0.99 @ 230 V AC / > 0.97 @ 115 V AC
> 20 ms @ 230 V AC / > 20 ms @ 115 V AC
/ 155 / 60 / 130 mm / 1300 g
Green LED, red LED
Output voltage > 21.6 V / < 20.4 V
CE; cULus; EAC; GL; TUEV

Connection data	
Wire connection method	
Number of terminals	
Wire cross-section, rigid min/max	mm ²
Wire cross-section, flexible min/max	mm ²
Wire cross-section, AWG/kcmil min/max	
Note	

Input	Output
Screw connection	Screw connection
3 for L/N/PE	6 (+, +, +, COM, NO)
0.5 / 6	0.5 / 6
0.5 / 2.5	0.5 / 2.5
26 / 12	26 / 12

Ordering data

Type	Qty.	Order No.
CP M SNT 250W 24V 10AUW	1	1165480010

Note

The internal varistor found in a switch-mode power supply does not replace the necessary surge protection in a system.
--

Accessories

Note

Small metal foot



Type	Order No.
MTA 30 MF	1251320000

Large metal foot



Type	Order No.
MTA 45 MF	1251310000

Small plastic foot



Type	Order No.
MTA 30 BK	1168970000

Large plastic foot



Type	Order No.
MTA 45 BK	1962250000

Small wall mounting



Type	Order No.
CP A WALLADAPTER 30 MM	1461870000

Large wall mounting



Type	Order No.
CP A WALLADAPTER 45 MM	1461850000

Small screwdriver



Type	Blade type	Size/AF	a	b	c	Order No.
SDIK PH1		1.00			80	9008570000
SDIS 0.5X3.0X100	B		0.5	3	100	9008380000

Large screwdriver



Type	Blade type	Size/AF	a	b	c	Order No.
SDIS 1.0X5.5X125	B		1	5.5	125	9008410000

Markers



Type	Colour	Qty.	Order No.
SM 18/9.5 K MC NE WS	white	200	1248580000

Endwinkel

For DIN rail TS 35



Polyamide with fibre glass, screwable	Colour	Torque	Qty.	Order No.
WEW 35/1 SW	black	1.2 Nm	50	1162600000

г. Минск www.fotorele.net www.tiristor.by email minsk17@tut.by тел. +375447584780

Supplying power even under difficult environmental conditions PROtop – the innovative power supply for demanding applications

High-end power supplies must perform efficiently and reliably, even in challenging industrial environments. High power reserves, long service life and optimal protection against surge voltages, vibrations and extreme temperature conditions are all a requirement.

New DCL technology provides PROtop with outstanding dynamic range. This can be used for the reliable triggering of circuit breaking switches as well as for powerful motor starts.

Its unique features make PROtop your first choice for reliability, service life and energy efficiency, even under extreme temperature and vibration conditions.



Extreme vibration and temperature resistance as well as its space- and cost-saving concept for redundant power supply systems make PROtop the optimal high-end solution for wind turbines

Your special advantages:

DCL technology

PROtop benefits from unique impulse energy reserves thanks to new DCL technology. Ideal for reliable impulse triggering of circuit breakers or as additional energy for powerful motor starts.



Flexible application due to various operating modes

In parallel operation mode (P: parallel operation, S: single operation), the output voltage can be easily adjusted and the output currents can be symmetrically balanced.

Programmable short-circuit behaviour (C: sustained short-circuit current, S: short-circuit switch-off) offers specific overload and wiring protection.



Futureproof with communicative power supplies

Available from November 2017 the communicative power supplies offer a new dimension of functional possibilities.



High peak power and excellent dynamic range thanks to the DCL technology

The peak current reserve of 600 % for 20 ms of innovative DCL technology reliably triggers circuit breakers. In addition, the continuous peak reserves from milliseconds to seconds ensure powerful motor starts.

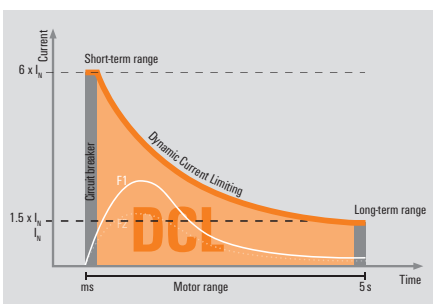

Efficient, extremely space-saving and long life cycle

Efficiencies of up to 95.4 % lead to low power losses and extremely space saving housings. The lower heating up even results in high MTBF (>1,000,000 h) and long life cycle of more than 20 years.

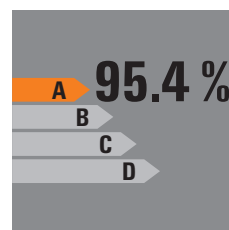

PROtop power supplies to satisfy the highest demands

PROtop

- DCL technology for an excellent dynamic range
- High energy efficiency (up to 95.4 % efficiency)
- Mode of operation: single or parallel operation and adjustable short-circuit response (continuous current or switch-off)
- Long service life of up to 20 years, MTBF > 1,000,000 h.
- Extremely slim design
- Time-saving PUSH IN connection technology



Derating curve

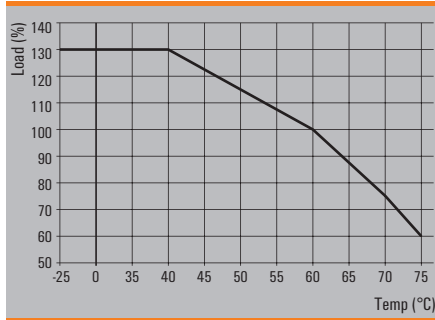

Technical data

General data	
Insulation voltage input / earth	4 kV
Insulation voltage output / earth	0.5 kV
Insulation voltage, input/output	4 kV
Earth leakage current, max.	3.5 mA
Series switching capability	Yes
Ambient temperature (operational) / Storage temperature	-25 °C...75 °C / -40 °C...85 °C
Humidity at operating temperature	5...95 %, no condensation
Class of protection / Pollution degree	I, with PE connection / 2
MTBF	> 1.000.000 h according IEC 1709 (SN29500)
Housing version	Metal, corrosion resistant
Mounting position, installation notice	Horizontal on DIN rail TS 35, top and bottom 50 mm clearance for free air flow, 10 mm clearance to neighbouring active subassemblies with full load, 5 mm with passive neighbouring subassemblies, direct row mounting with 90% rated load
EMC / shock / vibration	
Interference immunity test acc. to	EN 55024, EN 55032 (EN 55022), EN 61000-6-1, 2, 3, 4
Shock	30 g in all directions
Resistance to vibration	2.3 g (on DIN rail), 4 g (with direct mounting)
Electrical safety (applied standards)	
Electrical machine equipment	Acc. to EN60204
Safety transformers for switch-mode power supplies	nach EN61558-2-16
For use with electronic equipment	Acc. to EN50178 / VDE0160
Safety extra-low voltage	SELV acc. to EN60950, PELV acc. to EN60204
Protective separation / protection against electrical shock	VDE0100-410 / acc. to DIN57100-410
Protection against dangerous shock currents	Acc. to VDE0106-101

PROtop

- 1-phase power supplies

PRO TOP1 72 W 24 V 3 A



Similar to illustration

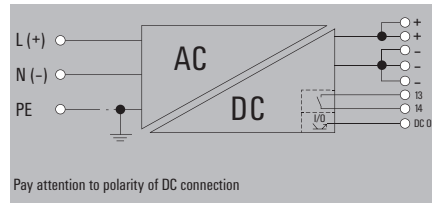

PRO TOP1 120 W 24 V 5 A



Similar to illustration

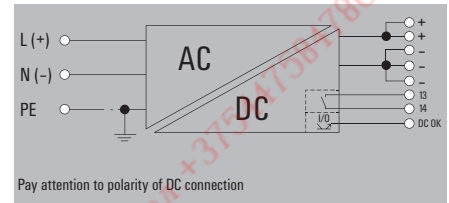

Technical data

Input
Rated input voltage
Input voltage range AC
Frequency range AC
DC input voltage range
Input fuse (internal) / Inrush current
Output
Rated output voltage
Output voltage
DCL - peak load reserve
Residual ripple, breaking spikes
Power reserve at nom. voltage
Rated (nominal) output current @ U_{Nom}
General data
Derating
Series switching capability
Degree of efficiency
Power factor (approx.)
AC failure bridging time @ I_{Nom}
LED green/red
Parallel connection option
Depth x width x height
Net weight
Approvals
Approvals

preliminary technical data!

100 - 240 V AC / 120 - 340 V DC
85...277 V AC
45...65 Hz
80 ... 410 V DC
Yes / max. 5 A
24 V DC \pm 1 %
22.5...29 V
150 % (5 s); 400 % (12 ms)
< 50 mVss @ U_{Nem} , Full Load
130% permanent at $\leq 40^{\circ}\text{C}$
3 A @ 60°C
> 60°C (2.5% / 1°C)
Yes
typ. 90 %
> 0.90 @ 230 V AC
> 20 ms @ 230 V AC / > 20 ms @ 115 V AC
Green: Operation (failure-free), Flashing green: advance warning
I>90%, Green/red flashing: output switched off (switch-off mode), Flashing red: overload/error
Passive Current Sharing
125 / 35 / 130 mm
650 g

preliminary technical data!

100 - 240 V AC / 120 - 340 V DC
85...277 V AC
45...65 Hz
48 ... 410 V DC (Derating 40 % @ 48 V DC)
Yes / max. 5 A
24 V DC \pm 1 %
22.5...29 V
150 % (5 s); 600 % (12 ms)
< 50 mVss @ U_{Nem} , Full Load
130% permanent at $\leq 40^{\circ}\text{C}$
5 A @ 60°C
> 60°C (2.5% / 1°C)
Yes
typ. 91 %
> 0.90 @ 230 V AC
> 20 ms @ 230 V AC / > 20 ms @ 115 V AC
Green: Operation (failure-free), Flashing green: advance warning
I>90%, Green/red flashing: output switched off (switch-off mode), Flashing red: overload/error
Passive Current Sharing
125 / 35 / 130 mm
850 g

Connection data	
Connection system	
Number of terminals	
Wire cross-section, rigid min/max	mm ²
Wire cross-section, flexible min/max	mm ²
Wire cross-section, AWG/kcmil min/max	

Input	Output
PUSH IN with actuator	PUSH IN with actuator
3 for L/N/PE	5 (+ + / - - -)
0.5 / 1.5	0.2 / 2.5
0.5 / 2.5	0.2 / 2.5
20 / 12	26 / 12

Input	Output
PUSH IN with actuator	PUSH IN with actuator
3 for L/N/PE	5 (+ + / - - -)
0.5 / 1.5	0.2 / 2.5
0.5 / 2.5	0.2 / 2.5
20 / 12	26 / 12

Note

Ordering data

Type	Qty.	Order No.
PRO TOP1 72W 24V 3A	1	2466850000

Type	Qty.	Order No.
PRO TOP1 120W 24V 5A	1	2466870000

Note

Current technical data on catalog.weidmueller.com

Current technical data on catalog.weidmueller.com

Accessories

Note

PROtop

- 1-phase power supplies

PRO TOP1 240 W 24 V 10 A



Similar to illustration

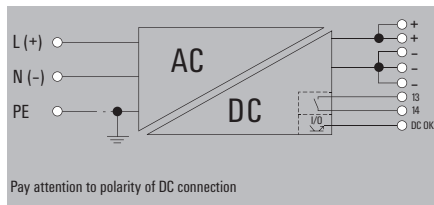

PRO TOP1 480 W 24 V 20 A



Similar to illustration

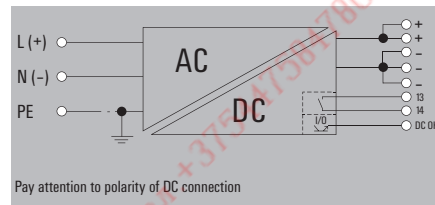

Technical data

Input	
Rated input voltage	100 - 240 V AC / 120 - 340 V DC
Input voltage range AC	85...277 V AC
Frequency range AC	45...65 Hz
DC input voltage range	80 ... 410 V DC
Input fuse (internal) / Inrush current	Yes / max. 5 A
Output	
Rated output voltage	24 V DC ± 1 %
Output voltage	22.5...29 V
DCL - peak load reserve	150 % (5 s); 600 % (12 ms)
Residual ripple, breaking spikes	< 50 mVss @ U _{Nom} , Full Load
Power reserve at nom. voltage	130% permanent at ≤ 40°C
Rated (nominal) output current @ U _{Nom}	10 A @ 60 °C
General data	
Derating	> 60°C (2.5% / 1°C)
Series switching capability	Yes
Degree of efficiency	typ. 92,5 %
Power factor (approx.)	> 0.90 @ 230 V AC
AC failure bridging time @ I _{Nom}	> 20 ms @ 230 V AC / > 20 ms @ 115 V AC
LED green/red	Green: Operation (failure-free), Flashing green: advance warning >90%, Green/red flashing: output switched off (switch-off mode), Flashing red: overload/error
Parallel connection option	Passive Current Sharing
Depth x width x height	125 / 39 / 130 mm
Net weight	1050 g
Approvals	
Approvals	

preliminary technical data!

Input	
Rated input voltage	100 - 240 V AC / 120 - 340 V DC
Input voltage range AC	85...277 V AC
Frequency range AC	45...65 Hz
DC input voltage range	80 ... 410 V DC
Input fuse (internal) / Inrush current	Yes / max. 5 A
Output	
Rated output voltage	24 V DC ± 1 %
Output voltage	22.5...29 V
DCL - peak load reserve	150 % (5 s); 600 % (12 ms)
Residual ripple, breaking spikes	< 50 mVss @ U _{Nom} , Full Load
Power reserve at nom. voltage	130% permanent at ≤ 40°C
Rated (nominal) output current @ U _{Nom}	10 A @ 60 °C
General data	
Derating	> 60°C (2.5% / 1°C)
Series switching capability	Yes
Degree of efficiency	typ. 92,5 %
Power factor (approx.)	> 0.90 @ 230 V AC
AC failure bridging time @ I _{Nom}	> 20 ms @ 230 V AC / > 20 ms @ 115 V AC
LED green/red	Green: Operation (failure-free), Flashing green: advance warning >90%, Green/red flashing: output switched off (switch-off mode), Flashing red: overload/error
Parallel connection option	Passive Current Sharing
Depth x width x height	125 / 39 / 130 mm
Net weight	1050 g

preliminary technical data!

Input	
Rated input voltage	100 - 240 V AC / 120 - 340 V DC
Input voltage range AC	85...277 V AC
Frequency range AC	45...65 Hz
DC input voltage range	80 ... 410 V DC
Input fuse (internal) / Inrush current	Yes / max. 5 A
Output	
Rated output voltage	24 V DC ± 1 %
Output voltage	22.5...29 V
DCL - peak load reserve	150 % (5 s); 500 % (12 ms)
Residual ripple, breaking spikes	< 50 mVss @ U _{Nom} , Full Load
Power reserve at nom. voltage	130% permanent at ≤ 40°C
Rated (nominal) output current @ U _{Nom}	20 A @ 60 °C
General data	
Derating	> 60°C (2.5% / 1°C)
Series switching capability	Yes
Degree of efficiency	typ. 93,5 %
Power factor (approx.)	> 0.90 @ 230 V AC
AC failure bridging time @ I _{Nom}	> 20 ms @ 230 V AC / > 20 ms @ 115 V AC
LED green/red	Green: Operation (failure-free), Flashing green: advance warning >90%, Green/red flashing: output switched off (switch-off mode), Flashing red: overload/error
Parallel connection option	Passive Current Sharing
Depth x width x height	125 / 68 / 130 mm
Net weight	1520 g

Connection data

Connection system	PUSH IN with actuator
Number of terminals	3 for L/N/PE
Wire cross-section, rigid min/max	0.5 / 1.5 mm ²
Wire cross-section, flexible min/max	0.5 / 2.5 mm ²
Wire cross-section, AWG/kcmil min/max	20 / 12

Input	Output
PUSH IN with actuator	PUSH IN with actuator
3 for L/N/PE	5 (+ + / - -)
0.5 / 1.5	0.2 / 2.5
0.5 / 2.5	0.2 / 2.5
20 / 12	26 / 12

Input	Output
PUSH IN	PUSH IN
3 for L/N/PE	5 (+ + / - -)
0.2 / 10	0.2 / 10
0.2 / 6	0.2 / 6
20 / 8	20 / 8

Note

Ordering data

Type	Qty.	Order No.
PRO TOP1 240W 24V 10A	1	2466880000

Type	Qty.	Order No.
PRO TOP1 240W 24V 10A	1	2466880000

Type	Qty.	Order No.
PRO TOP1 480W 24V 20A	1	2466890000

Note

Current technical data on catalog.weidmueller.com

Current technical data on catalog.weidmueller.com

Accessories

Note

PROtop

- 1-phase power supplies

PRO TOP1 960 W 24 V 40 A



Similar to illustration

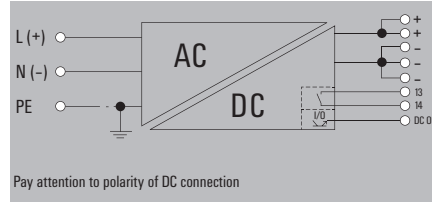

PRO TOP1 120 W 12 V 10 A



Similar to illustration

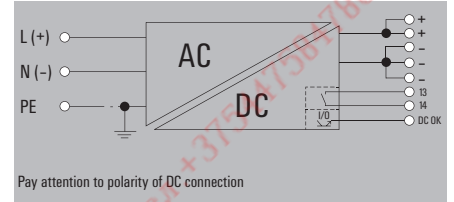

Technical data

Input	
Rated input voltage	100 - 240 V AC / 120 - 340 V DC
Input voltage range AC	85...277 V AC
Frequency range AC	45...65 Hz
DC input voltage range	80 ... 410 V DC
Input fuse (internal) / Inrush current	Yes / max. 15 A
Output	
Rated output voltage	24 V DC ± 1 %
Output voltage	22.5...29 V
DCL - peak load reserve	150 % (5 s); 300 % (12 ms)
Residual ripple, breaking spikes	< 50 mVss @ U _{Nom} , Full Load
Power reserve at nom. voltage	130% permanent at ≤ 40°C
Rated (nominal) output current @ U _{Nom}	40 A @ 60 °C
General data	
Derating	> 60°C (2.5% / 1°C)
Series switching capability	Yes
Degree of efficiency	typ. 94,5 %
Power factor (approx.)	> 0.90 @ 230 V AC
AC failure bridging time @ I _{Nom}	> 20 ms @ 230 V AC / > 20 ms @ 115 V AC
LED green/red	Green: Operation (failure-free), Flashing green: advance warning >90%, Green/red flashing: output switched off (switch-off mode), Flashing red: overload/error
Parallel connection option	Passive Current Sharing
Depth x width x height	125 / 124 / 130 mm
Net weight	3400 g
Approvals	
Approvals	

preliminary technical data!

Input	
Rated input voltage	100 - 240 V AC / 120 - 340 V DC
Input voltage range AC	85...277 V AC
Frequency range AC	45...65 Hz
DC input voltage range	80 ... 410 V DC
Input fuse (internal) / Inrush current	Yes / max. 15 A
Output	
Rated output voltage	24 V DC ± 1 %
Output voltage	22.5...29 V
DCL - peak load reserve	150 % (5 s); 300 % (12 ms)
Residual ripple, breaking spikes	< 50 mVss @ U _{Nom} , Full Load
Power reserve at nom. voltage	130% permanent at ≤ 40°C
Rated (nominal) output current @ U _{Nom}	40 A @ 60 °C
General data	
Derating	> 60°C (2.5% / 1°C)
Series switching capability	Yes
Degree of efficiency	typ. 94,5 %
Power factor (approx.)	> 0.90 @ 230 V AC
AC failure bridging time @ I _{Nom}	> 20 ms @ 230 V AC / > 20 ms @ 115 V AC
LED green/red	Green: Operation (failure-free), Flashing green: advance warning >90%, Green/red flashing: output switched off (switch-off mode), Flashing red: overload/error
Parallel connection option	Passive Current Sharing
Depth x width x height	125 / 124 / 130 mm
Net weight	3400 g

preliminary technical data!

Input	
Rated input voltage	100 - 240 V AC / 120 - 340 V DC
Input voltage range AC	85...277 V AC
Frequency range AC	45...65 Hz
DC input voltage range	80 ... 410 V DC
Input fuse (internal) / Inrush current	Yes / max. 5 A
Output	
Rated output voltage	12 V DC ± 1 %
Output voltage	11...15 V
DCL - peak load reserve	150 % (5 s); 400 % (12 ms)
Residual ripple, breaking spikes	< 50 mVss @ U _{Nom} , Full Load
Power reserve at nom. voltage	130% permanent at ≤ 40°C
Rated (nominal) output current @ U _{Nom}	10 A @ 60 °C
General data	
Derating	> 60°C (2.5% / 1°C)
Series switching capability	Yes
Degree of efficiency	typ. 90 %
Power factor (approx.)	> 0.90 @ 230 V AC
AC failure bridging time @ I _{Nom}	> 20 ms @ 230 V AC / > 20 ms @ 115 V AC
LED green/red	Green: Operation (failure-free), Flashing green: advance warning >90%, Green/red flashing: output switched off (switch-off mode), Flashing red: overload/error
Parallel connection option	Passive Current Sharing
Depth x width x height	125 / 35 / 130 mm
Net weight	850 g

Connection data	
Connection system	PUSH IN
Number of terminals	3 for L/N/PE
Wire cross-section, rigid min/max	0.75 / 16 mm ²
Wire cross-section, flexible min/max	0.75 / 16 mm ²
Wire cross-section, AWG/kcmil min/max	20 / 4

Input	Output
PUSH IN	PUSH IN
3 for L/N/PE	5 (+ + / - - -)
0.75 / 16	0.75 / 16
0.75 / 16	0.75 / 16
20 / 4	20 / 4

Input	Output
PUSH IN with actuator	PUSH IN with actuator
3 for L/N/PE	5 (+ + / - - -)
0.5 / 1.5	0.2 / 2.5
0.5 / 2.5	0.2 / 2.5
20 / 12	26 / 12

Note

Ordering data

Type	Qty.	Order No.
PRO TOP1 960W 24V 40A	1	246690000

Type	Qty.	Order No.
PRO TOP1 120W 12V 10A	1	246691000

Note
Current technical data on catalog.weidmueller.com

Note
Current technical data on catalog.weidmueller.com

Note
Current technical data on catalog.weidmueller.com

Accessories

Note

PROtop

- 1-phase power supplies

PRO TOP1 480 W 48 V 10 A



Similar to illustration

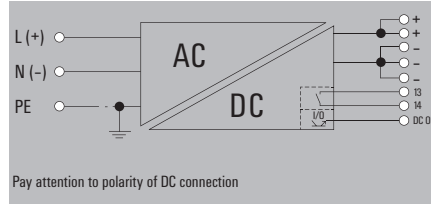

PRO TOP1 960 W 48 V 20 A



Similar to illustration

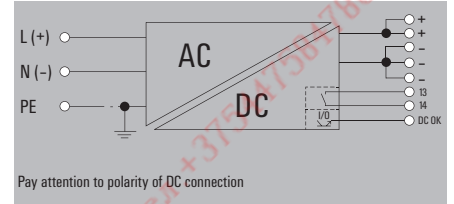

Technical data

Input	
Rated input voltage	100 - 240 V AC / 120 - 340 V DC
Input voltage range AC	85...277 V AC
Frequency range AC	45...65 Hz
DC input voltage range	80 ... 410 V DC
Input fuse (internal) / Inrush current	Yes / max. 5 A
Output	
Rated output voltage	48 V DC ± 1 %
Output voltage	45...56 V
DCL - peak load reserve	150 % (5 s); 600 % (12 ms)
Residual ripple, breaking spikes	< 50 mVss @ U _{Nom} , Full Load
Power reserve at nom. voltage	130% permanent at ≤ 40°C
Rated (nominal) output current @ U _{Nom}	10 A @ 60 °C
General data	
Derating	> 60°C (2.5% / 1°C)
Series switching capability	Yes
Degree of efficiency	typ. 93,5 %
Power factor (approx.)	> 0.90 @ 230 V AC
AC failure bridging time @ I _{Nom}	> 20 ms @ 230 V AC / > 20 ms @ 115 V AC
LED green/red	Green: Operation (failure-free), Flashing green: advance warning >90%, Green/red flashing: output switched off (switch-off mode), Flashing red: overload/error
Parallel connection option	Passive Current Sharing
Depth x width x height	125 / 68 / 130 mm
Net weight	1520 g
Approvals	
Approvals	

preliminary technical data!

Input	
Rated input voltage	100 - 240 V AC / 120 - 340 V DC
Input voltage range AC	85...277 V AC
Frequency range AC	45...65 Hz
DC input voltage range	80 ... 410 V DC
Input fuse (internal) / Inrush current	Yes / max. 5 A
Output	
Rated output voltage	48 V DC ± 1 %
Output voltage	45...56 V
DCL - peak load reserve	150 % (5 s); 600 % (12 ms)
Residual ripple, breaking spikes	< 50 mVss @ U _{Nom} , Full Load
Power reserve at nom. voltage	130% permanent at ≤ 40°C
Rated (nominal) output current @ U _{Nom}	10 A @ 60 °C
General data	
Derating	> 60°C (2.5% / 1°C)
Series switching capability	Yes
Degree of efficiency	typ. 93,5 %
Power factor (approx.)	> 0.90 @ 230 V AC
AC failure bridging time @ I _{Nom}	> 20 ms @ 230 V AC / > 20 ms @ 115 V AC
LED green/red	Green: Operation (failure-free), Flashing green: advance warning >90%, Green/red flashing: output switched off (switch-off mode), Flashing red: overload/error
Parallel connection option	Passive Current Sharing
Depth x width x height	125 / 68 / 130 mm
Net weight	1520 g

preliminary technical data!

Input	
Rated input voltage	100 - 240 V AC / 120 - 340 V DC
Input voltage range AC	85...277 V AC
Frequency range AC	45...65 Hz
DC input voltage range	80 ... 410 V DC
Input fuse (internal) / Inrush current	Yes / max. 15 A
Output	
Rated output voltage	48 V DC ± 1 %
Output voltage	45...56 V
DCL - peak load reserve	150 % (5 s); 500 % (12 ms)
Residual ripple, breaking spikes	< 50 mVss @ U _{Nom} , Full Load
Power reserve at nom. voltage	130% permanent at ≤ 40°C
Rated (nominal) output current @ U _{Nom}	20 A @ 60 °C
General data	
Derating	> 60°C (2.5% / 1°C)
Series switching capability	Yes
Degree of efficiency	typ. 94,5 %
Power factor (approx.)	> 0.90 @ 230 V AC
AC failure bridging time @ I _{Nom}	> 20 ms @ 230 V AC / > 20 ms @ 115 V AC
LED green/red	Green: Operation (failure-free), Flashing green: advance warning >90%, Green/red flashing: output switched off (switch-off mode), Flashing red: overload/error
Parallel connection option	Passive Current Sharing
Depth x width x height	125 / 124 / 130 mm
Net weight	3400 g

Connection data

Connection system	PUSH IN
Number of terminals	3 for L/N/PE
Wire cross-section, rigid min/max	0.2 / 10 mm ²
Wire cross-section, flexible min/max	0.2 / 6 mm ²
Wire cross-section, AWG/kcmil min/max	20 / 8

Input	Output
PUSH IN	PUSH IN
3 for L/N/PE	5 (+ + / - -)
0.2 / 10	0.2 / 10
0.2 / 6	0.2 / 6
20 / 8	20 / 8

Input	Output
PUSH IN	PUSH IN
3 for L/N/PE	5 (+ + / - -)
0.75 / 16	0.75 / 16
0.75 / 16	0.75 / 16
20 / 4	20 / 4

Note

Ordering data

Type	Qty.	Order No.
PRO TOP1 480W 48V 10A	1	2467030000

Type	Qty.	Order No.
PRO TOP1 960W 48V 20A	1	2466920000

Note

Current technical data on catalog.weidmueller.com

Current technical data on catalog.weidmueller.com

Accessories

Note

PROtop

- 3-phase power supplies

PRO TOP3 120 W 24 V 5 A

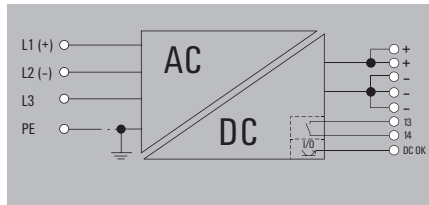

PRO TOP3 240 W 24 V 10 A

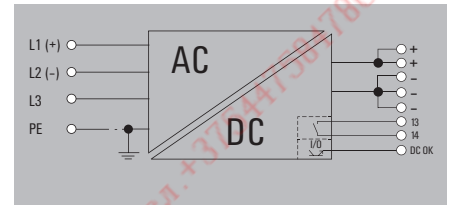

Technical data

Input
Rated input voltage
Input voltage range AC
Frequency range AC
DC input voltage range
Input fuse (internal) / Inrush current
Output
Rated output voltage
Output voltage
DCL - peak load reserve
Residual ripple, breaking spikes
Power reserve at nom. voltage
Rated (nominal) output current @ U_{Nom}
General data
Derating
Series switching capability
Degree of efficiency
Power factor (approx.)
AC failure bridging time @ I_{Nom}
LED green/red
Parallel connection option
Depth x width x height
Net weight
Approvals
Approvals

preliminary technical data!

3 x 400...3 x 500 V AC (wide-range input)
3 x 320...3 x 575 V AC / 2 x 360...2 x 575 V AC
45...65 Hz
450...800 V DC (max. 500 V DC acc. to UL508)
Yes
24 V DC \pm 1 %
22.5...29 V
150 % (5 s); 600 % (12 ms)
< 50 mVss @ U_{Nem} , Full Load
130% permanent at $\leq 40^{\circ}\text{C}$
5 A @ 60°C
> 60°C (2.5% / 1°C)
Yes
> 0.90 @ 230 V AC
> 20 ms @ 230 V AC / > 20 ms @ 115 V AC
Green: Operation (failure-free), Flashing green: advance warning
I>90%, Green/red flashing: output switched off (switch-off mode), Flashing red: overload/error
Passive Current Sharing
125 / 38 / 130 mm
865 g

preliminary technical data!

3 x 400...3 x 500 V AC (wide-range input)
3 x 320...3 x 575 V AC / 2 x 360...2 x 575 V AC
45...65 Hz
450...800 V DC (max. 500 V DC acc. to UL508)
Yes
24 V DC \pm 1 %
22.5...29 V
150 % (5 s); 600 % (12 ms)
< 50 mVss @ U_{Nem} , Full Load
130% permanent at $\leq 40^{\circ}\text{C}$
10 A @ 60°C
> 60°C (2.5% / 1°C)
Yes
> 0.90 @ 230 V AC
> 20 ms @ 230 V AC / > 20 ms @ 115 V AC
Green: Operation (failure-free), Flashing green: advance warning
I>90%, Green/red flashing: output switched off (switch-off mode), Flashing red: overload/error
Passive Current Sharing
125 / 49 / 130 mm
965 g

Connection data	
Connection system	
Number of terminals	
Wire cross-section, rigid min/max	mm ²
Wire cross-section, flexible min/max	mm ²
Wire cross-section, AWG/kcmil min/max	

Input	Output
PUSH IN with actuator	PUSH IN with actuator
4 for L1/L2/L3/PE	5 (+ / - / -)
0.5 / 1.5	0.2 / 2.5
0.5 / 2.5	0.2 / 2.5
20 / 12	26 / 12

Input	Output
PUSH IN with actuator	PUSH IN with actuator
4 for L1/L2/L3/PE	5 (+ / - / -)
0.5 / 1.5	0.2 / 2.5
0.5 / 2.5	0.2 / 2.5
20 / 12	26 / 12

Note

Note

Ordering data

Type	Qty.	Order No.
PRO TOP3 120W 24V 5A	1	2467060000

Type	Qty.	Order No.
PRO TOP3 120W 24V 5A	1	2467060000

Type	Qty.	Order No.
PRO TOP3 240W 24V 10A	1	2467080000

Note

Current technical data on catalog.weidmueller.com

Current technical data on catalog.weidmueller.com

Accessories

Note

Note

PROtop

- 3-phase power supplies

PRO TOP3 480 W 24 V 20 A

PRO TOP3 960 W 24 V 40 A

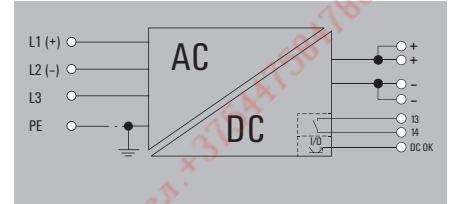
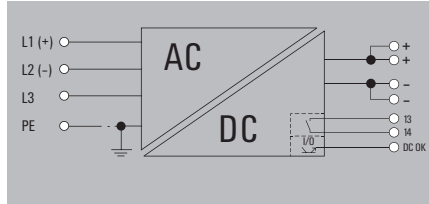

Technical data

Input	
Rated input voltage	3 x 400...3 x 500 V AC (wide-range input)
Input voltage range AC	3 x 320...3 x 575 V AC / 2 x 360...2 x 575 V AC
Frequency range AC	45...65 Hz
DC input voltage range	450...800 V DC (max. 500 V DC acc. to UL508)
Input fuse (internal) / Inrush current	Yes
Output	
Rated output voltage	24 V DC ± 1 %
Output voltage	22.5...29 V
DCL - peak load reserve	150 % (5 s); 500 % (12 ms)
Residual ripple, breaking spikes	< 50 mVss @ U _{Nom} , Full Load
Power reserve at nom. voltage	130% permanent at ≤ 40°C
Rated (nominal) output current @ U _{Nom}	20 A @ 60 °C
General data	
Derating	> 60°C (2.5% / 1°C)
Series switching capability	Yes
Degree of efficiency	> 0.90 @ 230 V AC
Power factor (approx.)	> 20 ms @ 230 V AC / > 20 ms @ 115 V AC
AC failure bridging time @ I _{Nom}	Green: Operation (failure-free), Flashing green: advance warning >90%, Green/red flashing: output switched off (switch-off mode), Flashing red: overload/error
LED green/red	Passive Current Sharing
Parallel connection option	125 / 68 / 130 mm
Depth x width x height	1450 g
Net weight	
Approvals	
Approvals	

preliminary technical data!

Input	
Rated input voltage	3 x 400...3 x 500 V AC (wide-range input)
Input voltage range AC	3 x 320...3 x 575 V AC / 2 x 360...2 x 575 V AC
Frequency range AC	45...65 Hz
DC input voltage range	450...800 V DC (max. 500 V DC acc. to UL508)
Input fuse (internal) / Inrush current	Yes
Output	
Rated output voltage	24 V DC ± 1 %
Output voltage	22.5...29 V
DCL - peak load reserve	150 % (5 s); 500 % (12 ms)
Residual ripple, breaking spikes	< 50 mVss @ U _{Nom} , Full Load
Power reserve at nom. voltage	130% permanent at ≤ 40°C
Rated (nominal) output current @ U _{Nom}	20 A @ 60 °C
General data	
Derating	> 60°C (2.5% / 1°C)
Series switching capability	Yes
Degree of efficiency	> 0.90 @ 230 V AC
Power factor (approx.)	> 20 ms @ 230 V AC / > 20 ms @ 115 V AC
AC failure bridging time @ I _{Nom}	Green: Operation (failure-free), Flashing green: advance warning >90%, Green/red flashing: output switched off (switch-off mode), Flashing red: overload/error
LED green/red	Passive Current Sharing
Parallel connection option	125 / 68 / 130 mm
Depth x width x height	1450 g
Net weight	
Approvals	
Approvals	

preliminary technical data!

Input	
Rated input voltage	3 x 400...3 x 500 V AC (wide-range input)
Input voltage range AC	3 x 320...3 x 575 V AC / 2 x 360...2 x 575 V AC
Frequency range AC	45...65 Hz
DC input voltage range	450...800 V DC (max. 500 V DC acc. to UL508)
Input fuse (internal) / Inrush current	Yes
Output	
Rated output voltage	24 V DC ± 1 %
Output voltage	22.5...29 V
DCL - peak load reserve	150 % (5 s); 300 % (12 ms)
Residual ripple, breaking spikes	< 50 mVss @ U _{Nom} , Full Load
Power reserve at nom. voltage	130% permanent at ≤ 40°C
Rated (nominal) output current @ U _{Nom}	40 A @ 60 °C
General data	
Derating	> 60°C (2.5% / 1°C)
Series switching capability	Yes
Degree of efficiency	> 0.90 @ 230 V AC
Power factor (approx.)	> 20 ms @ 230 V AC / > 20 ms @ 115 V AC
AC failure bridging time @ I _{Nom}	Green: Operation (failure-free), Flashing green: advance warning >90%, Green/red flashing: output switched off (switch-off mode), Flashing red: overload/error
LED green/red	Passive Current Sharing
Parallel connection option	175 / 90 / 130 mm
Depth x width x height	2490 g
Net weight	
Approvals	
Approvals	

Connection data

Connection system	PUSH IN
Number of terminals	4 for L1/L2/L3/PE
Wire cross-section, rigid min/max	0.2 / 10 mm ²
Wire cross-section, flexible min/max	0.2 / 6 mm ²
Wire cross-section, AWG/kcmil min/max	20 / 8

Input	Output
PUSH IN	PUSH IN
4 for L1/L2/L3/PE	4 (++ / -)
0.2 / 10	0.2 / 10
0.2 / 6	0.2 / 6
20 / 8	20 / 8

Input	Output
PUSH IN	PUSH IN
4 for L1/L2/L3/PE	4 (++ / -)
0.75 / 16	0.75 / 16
0.75 / 16	0.75 / 16
20 / 4	20 / 4

Note

Ordering data

Type	Qty.	Order No.
PRO TOP3 480W 24V 20A	1	2467100000

Type	Qty.	Order No.
PRO TOP3 960W 24V 40A	1	2467120000

Note

Current technical data on catalog.weidmueller.com

Current technical data on catalog.weidmueller.com

Accessories

Note

PROtop

- 3-phase power supplies

PRO TOP3 480 W 48 V 10 A

PRO TOP3 960 W 48 V 20 A

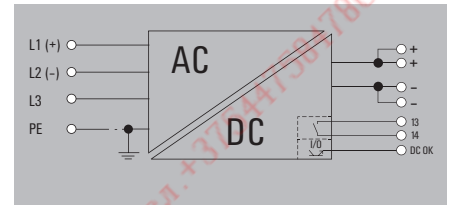
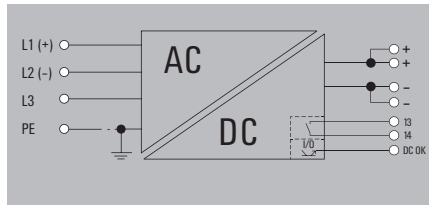

Technical data

Input
Rated input voltage
Input voltage range AC
Frequency range AC
DC input voltage range
Input fuse (internal) / Inrush current
Output
Rated output voltage
Output voltage
DCL - peak load reserve
Residual ripple, breaking spikes
Power reserve at nom. voltage
Rated (nominal) output current @ U_{Nom}
General data
Derating
Series switching capability
Degree of efficiency
Power factor (approx.)
AC failure bridging time @ I_{Nom}
LED green/red
Parallel connection option
Depth x width x height
Net weight
Approvals
Approvals

preliminary technical data!

3 x 400...3 x 500 V AC (wide-range input)
3 x 320...3 x 575 V AC / 2 x 360...2 x 575 V AC
45...65 Hz
450...800 V DC (max. 500 V DC acc. to UL508)
Yes
24 V DC \pm 1 %
45...56 V
150 % (5 s); 500 % (12 ms)
< 50 mVss @ U_{Nem} , Full Load
130% permanent at \leq 40°C
10 A @ 60 °C
> 60°C (2.5% / 1°C)
No
> 0.90 @ 230 V AC
> 20 ms @ 230 V AC / > 20 ms @ 115 V AC
Green: Operation (failure-free), Flashing green: advance warning
I>90%, Green/red flashing: output switched off (switch-off mode), Flashing red: overload/error
Passive Current Sharing
125 / 68 / 130 mm
1450 g

preliminary technical data!

3 x 400...3 x 500 V AC (wide-range input)
3 x 320...3 x 575 V AC / 2 x 360...2 x 575 V AC
45...65 Hz
450...800 V DC (max. 500 V DC acc. to UL508)
Yes
24 V DC \pm 1 %
45...56 V
150 % (5 s); 300 % (12 ms)
< 50 mVss @ U_{Nem} , Full Load
130% permanent at \leq 40°C
20 A @ 60 °C
> 60°C (2.5% / 1°C)
No
> 0.90 @ 230 V AC
> 20 ms @ 230 V AC / > 20 ms @ 115 V AC
Green: Operation (failure-free), Flashing green: advance warning
I>90%, Green/red flashing: output switched off (switch-off mode), Flashing red: overload/error
Passive Current Sharing
175 / 90 / 130 mm
2490 g

Connection data	
Connection system	
Number of terminals	
Wire cross-section, rigid min/max	mm ²
Wire cross-section, flexible min/max	mm ²
Wire cross-section, AWG/kcmil min/max	

Input	Output
PUSH IN	PUSH IN
4 for L1/L2/L3/PE	4 (++ / -)
0.2 / 10	0.2 / 10
0.2 / 6	0.2 / 6
20 / 8	20 / 8

Input	Output
PUSH IN	PUSH IN
4 for L1/L2/L3/PE	4 (++ / -)
0.75 / 16	0.75 / 16
0.75 / 16	0.75 / 16
20 / 4	20 / 4

Note

Ordering data

Type	Qty.	Order No.
PRO TOP3 480W 48V 10A	1	2467150000

Type	Qty.	Order No.
PRO TOP3 960W 48V 20A	1	2467170000

Note

Current technical data on catalog.weidmueller.com

Current technical data on catalog.weidmueller.com

Accessories

Note

Small metal foot



Type	Order No.
MTA 30 MF	1251320000

Large metal foot



Type	Order No.
MTA 45 MF	1251310000

Small plastic foot



Type	Order No.
MTA 30 BK	1168970000

Large plastic foot



Type	Order No.
MTA 45 BK	1962250000

Small wall mounting



Type	Order No.
CP A WALLADAPTER 30 MM	1461870000

Large wall mounting



Type	Order No.
CP A WALLADAPTER 45 MM	1461850000

Screwdriver

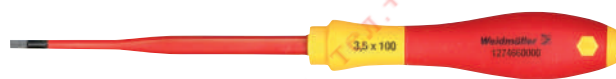

Type	Blade type	Size/AF	a	b	c	Order No.
SDIS SL 0.6X3.5X100			0.6	3.5	100	1274660000
SDIS SL 0.8X4.0X100			0.8	4	100	1274670000

Markers



Type	Colour	Qty.	Order No.
SM 18/9.5 K MC NE WS	white	200	1248580000

Endwinkel

For DIN rail TS 35



Polyamide with fibre glass, screwable	Colour	Torque	Qty.	Order No.
WEW 35/1 SW	black	1.2 Nm	50	1162600000

г. Минск www.fotorele.net www.tiristor.by email minsk17@tut.by тел. +375447584780

connectPower PRO-E

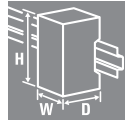

CP E SNT 25W 5V 5A



CP E SNT 25W 12V 2.1A

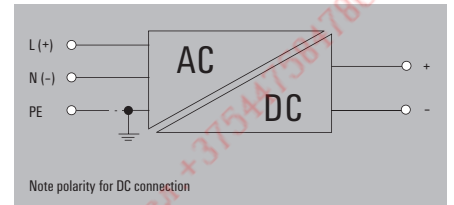
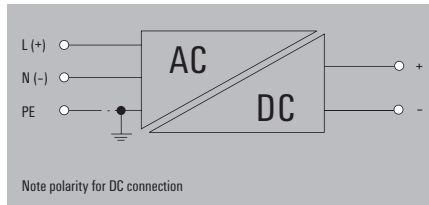

Technical data

Input	
Input voltage	
Input current	
Input frequency	
Input fuse (internal)	
Recommended back-up fuse	
Output	
Output voltage	
Output voltage adjustment	
Output current	
Output power	
Residual ripple, breaking spikes	
Overload protection	
Surge protection	
Mains failure bridge-over time	
Control at 10...100% load	
Parallel connection option	
Insulation coordination	
electrical isolation, output-earth	
electrical isolation, input-earth	
electrical isolation, input-output	
General data	
Ambient temperature (operational)	
Storage temperature	
Max. perm. air humidity (operational)	
Degree of efficiency	
Status indicator	
Standards	
EMC standards	
Mounting position, installation notice	
Net weight	
Approvals	
Screw connection	
Connection cross-section, solid, min. / max.	
Depth x width x height	
Note	

Input voltage	85...264 V AC / 110...370 V DC
Input current	0.3 A @ 230 V AC / 0.6 A @ 120 V AC
Input frequency	47...63 Hz
Input fuse (internal)	yes / max. 20A
Recommended back-up fuse	1 A at 230 V AC, characteristic curve C
Output voltage	5 V DC
Output voltage adjustment	± 10% nominal output voltage tolerance, adjustable with potentiometer
Output current	5 A @ 5 V DC
Output power	25 W
Residual ripple, breaking spikes	< 100 mV _{pp}
Overload protection	120~150% I _{konst.} of max. output power, automatic restart
Surge protection	5.6...6.8 V @ 5 V DC
Mains failure bridge-over time	20 ms
Control at 10...100% load	0.5%
Parallel connection option	Recommended with diode module
electrical isolation, output-earth	0.5 kV
electrical isolation, input-earth	1.5 kV
electrical isolation, input-output	3 kV
Ambient temperature (operational)	-20°C...70°C (>50°C derating, refer derated curve); 70% rated load @ 70°C
Storage temperature	-20 °C...85 °C
Max. perm. air humidity (operational)	5 %...95 % RH
Degree of efficiency	77 % @ 5 V DC
Status indicator	Operation, green LED
Standards	EN 60950
EMC standards	EN 55011, EN 55022, EN 55024, EN 61000-6 /2, -3
Mounting position, installation notice	Panel mount, screw fix
Net weight	157 g
Approvals	CE; cURus; EAC
Connection cross-section, solid, min. / max.	0.34 / 4 mm ²
Depth x width x height	91 / 51 / 28 mm
Note	

Input voltage	85...264 V AC / 110...370 V DC
Input current	0.3 A @ 230 V AC / 0.6 A @ 120 V AC
Input frequency	47...63 Hz
Input fuse (internal)	yes / max. 20A
Recommended back-up fuse	1 A at 230 V AC, characteristic curve C
Output voltage	12 V DC
Output voltage adjustment	± 10% nominal output voltage tolerance, adjustable with potentiometer
Output current	2.1 A @ 12 V DC
Output power	25 W
Residual ripple, breaking spikes	< 100 mV _{pp}
Overload protection	120~150% I _{konst.} of max. output power, automatic restart
Surge protection	13.5...16.2 V @ 12 V DC
Mains failure bridge-over time	20 ms
Control at 10...100% load	0.5%
Parallel connection option	Recommended with diode module
electrical isolation, output-earth	0.5 kV
electrical isolation, input-earth	1.5 kV
electrical isolation, input-output	3 kV
Ambient temperature (operational)	-20°C...70°C (>50°C derating, refer derated curve); 70% rated load @ 70°C
Storage temperature	-20 °C...85 °C
Max. perm. air humidity (operational)	5 %...95 % RH
Degree of efficiency	79 % @ 12 V DC
Status indicator	Operation, green LED
Standards	EN 60950
EMC standards	EN 55011, EN 55022, EN 55024, EN 61000-6 /2, -3
Mounting position, installation notice	Panel mount, screw fix
Net weight	154 g
Approvals	CE; cURus; EAC
Connection cross-section, solid, min. / max.	0.34 / 4 mm ²
Depth x width x height	91 / 51 / 28 mm
Note	

Ordering data

Type	Qty.	Order No.
CP E SNT 25W 5V 5A	1	1202640000

Type	Qty.	Order No.
CP E SNT 25W 12V 2.1A	1	1202630000

Note
The internal varistor found in a switch-mode power supply does not replace the necessary surge protection in a system.

Note
The internal varistor found in a switch-mode power supply does not replace the necessary surge protection in a system.

Accessories

Note

Note

connectPower
PRO-E

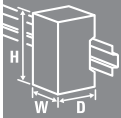

CP E SNT 25W 24V 1.1A

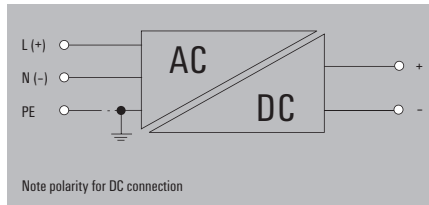

CP E SNT 25W 48V 0.57A

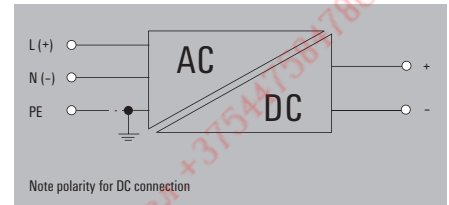

Technical data

Input	
Input voltage	
Input current	
Input frequency	
Input fuse (internal)	
Recommended back-up fuse	
Output	
Output voltage	
Output voltage adjustment	
Output current	
Output power	
Residual ripple, breaking spikes	
Overload protection	
Surge protection	
Mains failure bridge-over time	
Control at 10...100% load	
Parallel connection option	
Insulation coordination	
electrical isolation, output-earth	
electrical isolation, input-earth	
electrical isolation, input-output	
General data	
Ambient temperature (operational)	
Storage temperature	
Max. perm. air humidity (operational)	
Degree of efficiency	
Status indicator	
Standards	
EMC standards	
Mounting position, installation notice	
Net weight	
Approvals	
Screw connection	
Connection cross-section, solid, min. / max.	
Depth x width x height	
Note	

Input voltage	85...264 V AC / 110...370 V DC
Input current	0.3 A @ 230 V AC / 0.6 A @ 120 V AC
Input frequency	47...63 Hz
Input fuse (internal)	yes / max. 20A
Recommended back-up fuse	1 A at 230 V AC, characteristic curve C
Output voltage	24 V DC
Output voltage adjustment	± 10% nominal output voltage tolerance, adjustable with potentiometer
Output current	1.1 A@24 V DC
Output power	25 W
Residual ripple, breaking spikes	< 100 mV _{pp}
Overload protection	120~150% I _{konst.} of max. output power, automatic restart
Surge protection	28...32 V @ 24 V DC
Mains failure bridge-over time	20 ms
Control at 10...100% load	0.5%
Parallel connection option	Recommended with diode module
electrical isolation, output-earth	0.5 kV
electrical isolation, input-earth	1.5 kV
electrical isolation, input-output	3 kV
Ambient temperature (operational)	-20°C...70°C (>50°C derating, refer derated curve); 70% rated load@70°C
Storage temperature	-20 °C...85 °C
Max. perm. air humidity (operational)	5 %...95 % RH
Degree of efficiency	84 % @ 24 V DC
Status indicator	Operation, green LED
Standards	EN 60950
EMC standards	EN 55011, EN 55022, EN 55024, EN 61000-6 /-2, -3
Mounting position, installation notice	Panel mount, screw fix
Net weight	151 g
Approvals	CE; cURus; EAC
Connection cross-section, solid, min. / max.	0.34 / 4 mm ²
Depth x width x height	91 / 51 / 28 mm
Note	

Input voltage	85...264 V AC / 110...370 V DC
Input current	0.3 A @ 230 V AC / 0.6 A @ 120 V AC
Input frequency	47...63 Hz
Input fuse (internal)	yes / max. 20A
Recommended back-up fuse	1 A at 230 V AC, characteristic curve C
Output voltage	48 V DC
Output voltage adjustment	± 10% nominal output voltage tolerance, adjustable with potentiometer
Output current	0.57 A@48 V DC
Output power	25 W
Residual ripple, breaking spikes	< 100 mV _{pp}
Overload protection	120~150% I _{konst.} of max. output power, automatic restart
Surge protection	55...62 V @ 48 V DC
Mains failure bridge-over time	20 ms
Control at 10...100% load	0.5%
Parallel connection option	Recommended with diode module
electrical isolation, output-earth	0.5 kV
electrical isolation, input-earth	1.5 kV
electrical isolation, input-output	3 kV
Ambient temperature (operational)	-20°C...70°C (>50°C derating, refer derated curve); 70% rated load@70°C
Storage temperature	-20 °C...85 °C
Max. perm. air humidity (operational)	5 %...95 % RH
Degree of efficiency	83 % @ 48 V DC
Status indicator	Operation, green LED
Standards	EN 60950
EMC standards	EN 55011, EN 55022, EN 55024, EN 61000-6 /-2, -3
Mounting position, installation notice	Panel mount, screw fix
Net weight	156 g
Approvals	CE; cURus; EAC
Connection cross-section, solid, min. / max.	0.34 / 4 mm ²
Depth x width x height	91 / 51 / 28 mm
Note	

Ordering data

Type	Qty.	Order No.
CP E SNT 25W 24V 1.1A	1	1202620000

Type	Qty.	Order No.
CP E SNT 25W 48V 0.57A	1	1202610000

Note
The internal varistor found in a switch-mode power supply does not replace the necessary surge protection in a system.

Note
The internal varistor found in a switch-mode power supply does not replace the necessary surge protection in a system.

Accessories

Note

Note

connectPower PRO-E

connectPower PRO-E

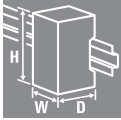

CP E SNT 50W 5V 10A

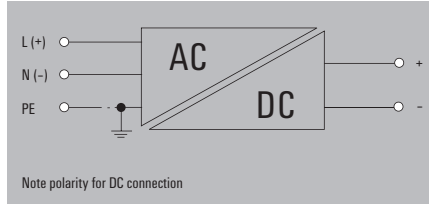

CP E SNT 50 W 12V 4.2A

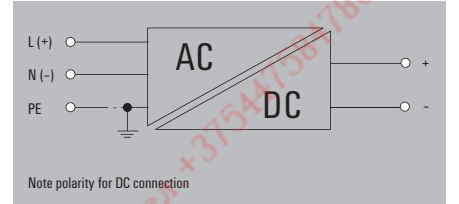

Technical data

Input	
Input voltage	
Input current	
Input frequency	
Input fuse (internal)	
Recommended back-up fuse	
Output	
Output voltage	
Output voltage adjustment	
Output current	
Output power	
Residual ripple, breaking spikes	
Overload protection	
Surge protection	
Mains failure bridge-over time	
Control at 10...100% load	
Parallel connection option	
Insulation coordination	
electrical isolation, output-earth	
electrical isolation, input-earth	
electrical isolation, input-output	
General data	
Ambient temperature (operational)	
Storage temperature	
Max. perm. air humidity (operational)	
Degree of efficiency	
Status indicator	
Standards	
EMC standards	
Mounting position, installation notice	
Net weight	
Approvals	
Screw connection	
Connection cross-section, solid, min. / max.	
Depth x width x height	
Note	

Input voltage	85...264 V AC / 110...370 V DC
Input current	0.6 A @ 230 V AC / 1.2 A @ 120 V AC
Input frequency	47...63 Hz
Input fuse (internal)	yes / max. 20A
Recommended back-up fuse	2 A at 230 V AC, characteristic curve C
Output voltage	5 V DC
Output voltage adjustment	± 10% nominal output voltage tolerance, adjustable with potentiometer
Output current	10 A@5 V DC
Output power	50 W
Residual ripple, breaking spikes	< 100 mV _{pp}
Overload protection	120~150% I _{konst.} of max. output power, automatic restart
Surge protection	5.6...6.8 V @ 5 V DC
Mains failure bridge-over time	20 ms
Control at 10...100% load	0.5%
Parallel connection option	Recommended with diode module
electrical isolation, output-earth	0.5 kV
electrical isolation, input-earth	1.5 kV
electrical isolation, input-output	3 kV
Ambient temperature (operational)	-20°C...70°C (>50°C derating, refer derated curve); 70% rated load@70°C
Storage temperature	-20 °C...85 °C
Max. perm. air humidity (operational)	5 %...95 % RH
Degree of efficiency	78 % @ 5 V DC
Status indicator	Operation, green LED
Standards	EN 60950
EMC standards	EN 55011, EN 55022, EN 55024, EN 61000-6 /2, -3
Mounting position, installation notice	Panel mount, screw fix
Net weight	333 g
Approvals	CE; cURus; EAC
Connection cross-section, solid, min. / max.	0.34 / 4 mm ²
Depth x width x height	105 / 100 / 35 mm
Note	

Input voltage	85...264 V AC / 110...370 V DC
Input current	0.6 A @ 230 V AC / 1.2 A @ 120 V AC
Input frequency	47...63 Hz
Input fuse (internal)	yes / max. 20A
Recommended back-up fuse	2 A at 230 V AC, characteristic curve C
Output voltage	12 V DC
Output voltage adjustment	± 10% nominal output voltage tolerance, adjustable with potentiometer
Output current	4.2 A@12 V DC
Output power	50 W
Residual ripple, breaking spikes	< 100 mV _{pp}
Overload protection	120~150% I _{konst.} of max. output power, automatic restart
Surge protection	13.5...16.2 V @ 12 V DC
Mains failure bridge-over time	20 ms
Control at 10...100% load	0.5%
Parallel connection option	Recommended with diode module
electrical isolation, output-earth	0.5 kV
electrical isolation, input-earth	1.5 kV
electrical isolation, input-output	3 kV
Ambient temperature (operational)	-20°C...70°C (>50°C derating, refer derated curve); 70% rated load@70°C
Storage temperature	-20 °C...85 °C
Max. perm. air humidity (operational)	5 %...95 % RH
Degree of efficiency	81 % @ 12 V DC
Status indicator	Operation, green LED
Standards	EN 60950
EMC standards	EN 55011, EN 55022, EN 55024, EN 61000-6 /2, -3
Mounting position, installation notice	Panel mount, screw fix
Net weight	331 g
Approvals	CE; cURus; EAC
Connection cross-section, solid, min. / max.	0.34 / 4 mm ²
Depth x width x height	105 / 100 / 35 mm
Note	

Ordering data

Type	Qty.	Order No.
CP E SNT 50W 5V 10A	1	1202590000

Type	Qty.	Order No.
CP E SNT 50W 12V 4.2A	1	1202580000

Note
The internal varistor found in a switch-mode power supply does not replace the necessary surge protection in a system.

Note
The internal varistor found in a switch-mode power supply does not replace the necessary surge protection in a system.

Accessories

Note

Note

connectPower
PRO-E

CP E SNT 50W 24V 2.2A

CP E SNT 50W 48V 1.1A

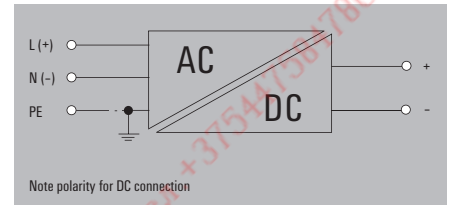
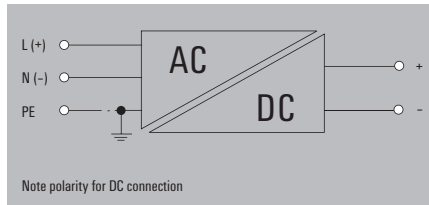
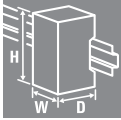

Technical data

Input	
Input voltage	
Input current	
Input frequency	
Input fuse (internal)	
Recommended back-up fuse	
Output	
Output voltage	
Output voltage adjustment	
Output current	
Output power	
Residual ripple, breaking spikes	
Overload protection	
Surge protection	
Mains failure bridge-over time	
Control at 10...100% load	
Parallel connection option	
Insulation coordination	
electrical isolation, output-earth	
electrical isolation, input-earth	
electrical isolation, input-output	
General data	
Ambient temperature (operational)	
Storage temperature	
Max. perm. air humidity (operational)	
Degree of efficiency	
Status indicator	
Standards	
EMC standards	
Mounting position, installation notice	
Net weight	
Approvals	
Screw connection	
Connection cross-section, solid, min. / max.	
Depth x width x height	
Note	

Input voltage	85...264 V AC / 110...370 V DC
Input current	0.6 A @ 230 V AC / 1.2 A @ 120 V AC
Input frequency	47...63 Hz
Input fuse (internal)	yes / max. 20A
Recommended back-up fuse	2 A at 230 V AC, characteristic curve C
Output voltage	24 V DC
Output voltage adjustment	± 10% nominal output voltage tolerance, adjustable with potentiometer
Output current	2.2 A@24 V DC
Output power	50 W
Residual ripple, breaking spikes	< 100 mV _{pp}
Overload protection	120~150% I _{konst.} of max. output power, automatic restart
Surge protection	28...32 V @ 24 V DC
Mains failure bridge-over time	20 ms
Control at 10...100% load	0.5%
Parallel connection option	Recommended with diode module
electrical isolation, output-earth	0.5 kV
electrical isolation, input-earth	1.5 kV
electrical isolation, input-output	3 kV
Ambient temperature (operational)	-20°C...70°C (>50°C derating, refer derated curve); 70% rated load@70°C
Storage temperature	-20 °C...85 °C
Max. perm. air humidity (operational)	5 %...95 % RH
Degree of efficiency	84 % @ 24 V DC
Status indicator	Operation, green LED
Standards	EN 60950
EMC standards	EN 55011, EN 55022, EN 55024, EN 61000-6 /2, -3
Mounting position, installation notice	Panel mount, screw fix
Net weight	320 g
Approvals	CE; cURus; EAC
Connection cross-section, solid, min. / max.	0.34 / 4 mm ²
Depth x width x height	105 / 100 / 35 mm
Note	

Input voltage	85...264 V AC / 110...370 V DC
Input current	0.6 A @ 230 V AC / 1.2 A @ 120 V AC
Input frequency	47...63 Hz
Input fuse (internal)	yes / max. 20A
Recommended back-up fuse	2 A at 230 V AC, characteristic curve C
Output voltage	48 V DC
Output voltage adjustment	± 10% nominal output voltage tolerance, adjustable with potentiometer
Output current	1.1 A@48 V DC
Output power	50 W
Residual ripple, breaking spikes	< 100 mV _{pp}
Overload protection	120~150% I _{konst.} of max. output power, automatic restart
Surge protection	55...62 V @ 48 V DC
Mains failure bridge-over time	20 ms
Control at 10...100% load	0.5%
Parallel connection option	Recommended with diode module
electrical isolation, output-earth	0.5 kV
electrical isolation, input-earth	1.5 kV
electrical isolation, input-output	3 kV
Ambient temperature (operational)	-20°C...70°C (>50°C derating, refer derated curve); 70% rated load@70°C
Storage temperature	-20 °C...85 °C
Max. perm. air humidity (operational)	5 %...95 % RH
Degree of efficiency	86 % @ 48 V DC
Status indicator	Operation, green LED
Standards	EN 60950
EMC standards	EN 55011, EN 55022, EN 55024, EN 61000-6 /2, -3
Mounting position, installation notice	Panel mount, screw fix
Net weight	340 g
Approvals	CE; cURus; EAC
Connection cross-section, solid, min. / max.	0.34 / 4 mm ²
Depth x width x height	105 / 100 / 35 mm
Note	

Ordering data

Type	Qty.	Order No.
CP E SNT 50W 24V 2.2A	1	1202450000

Type	Qty.	Order No.
CP E SNT 50W 48V 1.1A	1	1202460000

Note

The internal varistor found in a switch-mode power supply does not replace the necessary surge protection in a system.

The internal varistor found in a switch-mode power supply does not replace the necessary surge protection in a system.

Accessories

Note

connectPower PRO-E

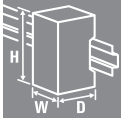

CP E SNT 75W 5V 12A

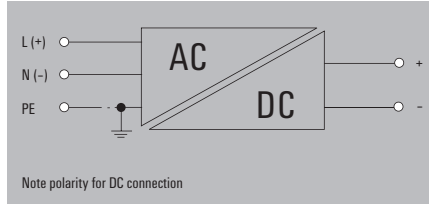

CP E SNT 75W 12V 6A

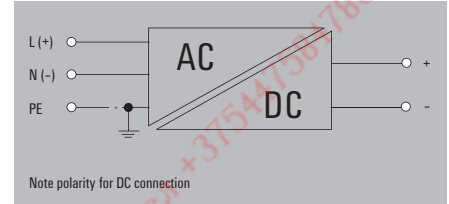

Technical data

Input	
Input voltage	
Input current	
Input frequency	
Input fuse (internal)	
Recommended back-up fuse	
Output	
Output voltage	
Output voltage adjustment	
Output current	
Output power	
Residual ripple, breaking spikes	
Overload protection	
Surge protection	
Mains failure bridge-over time	
Control at 10...100% load	
Parallel connection option	
Insulation coordination	
electrical isolation, output-earth	
electrical isolation, input-earth	
electrical isolation, input-output	
General data	
Ambient temperature (operational)	
Storage temperature	
Max. perm. air humidity (operational)	
Degree of efficiency	
Status indicator	
Standards	
EMC standards	
Mounting position, installation notice	
Net weight	
Approvals	
Screw connection	
Connection cross-section, solid, min. / max.	
Depth x width x height	
Note	

Input voltage	85...264 V AC / 110...370 V DC
Input current	1 A @ 230 V AC / 2 A @ 120 V AC
Input frequency	47...63 Hz
Input fuse (internal)	yes / max. 20A
Recommended back-up fuse	4 A at 230 V AC, characteristic curve C
Output voltage	5 V DC
Output voltage adjustment	± 10% nominal output voltage tolerance, adjustable with potentiometer
Output current	12 A@5 V DC
Output power	75 W
Residual ripple, breaking spikes	< 100 mV _{pp}
Overload protection	120~150% I _{konst.} of max. output power, automatic restart
Surge protection	5.6...6.8 V @ 5 V DC
Mains failure bridge-over time	20 ms
Control at 10...100% load	0.5%
Parallel connection option	Recommended with diode module
electrical isolation, output-earth	0.5 kV
electrical isolation, input-earth	1.5 kV
electrical isolation, input-output	3 kV
Ambient temperature (operational)	-20°C...70°C (>50°C derating, refer derated curve); 70% rated load@70°C
Storage temperature	-20 °C...85 °C
Max. perm. air humidity (operational)	5 %...95 % RH
Degree of efficiency	76 % @ 5 V DC
Status indicator	Operation, green LED
Standards	EN 60950
EMC standards	EN 55011, EN 55022, EN 55024, EN 61000-6 /2, -3
Mounting position, installation notice	Panel mount, screw fix
Net weight	430 g
Approvals	CE; cURus; EAC
Connection cross-section, solid, min. / max.	0.34 / 4 mm ²
Depth x width x height	135 / 98.5 / 40 mm
Note	

Input voltage	85...264 V AC / 110...370 V DC
Input current	1 A @ 230 V AC / 2 A @ 120 V AC
Input frequency	47...63 Hz
Input fuse (internal)	yes / max. 20A
Recommended back-up fuse	4 A at 230 V AC, characteristic curve C
Output voltage	12 V DC
Output voltage adjustment	± 10% nominal output voltage tolerance, adjustable with potentiometer
Output current	6 A@12 V DC
Output power	75 W
Residual ripple, breaking spikes	< 100 mV _{pp}
Overload protection	120~150% I _{konst.} of max. output power, automatic restart
Surge protection	13.5...16.2 V @ 12 V DC
Mains failure bridge-over time	20 ms
Control at 10...100% load	0.5%
Parallel connection option	Recommended with diode module
electrical isolation, output-earth	0.5 kV
electrical isolation, input-earth	1.5 kV
electrical isolation, input-output	3 kV
Ambient temperature (operational)	-20°C...70°C (>50°C derating, refer derated curve); 70% rated load@70°C
Storage temperature	-20 °C...85 °C
Max. perm. air humidity (operational)	5 %...95 % RH
Degree of efficiency	81 % @ 12 V DC
Status indicator	Operation, green LED
Standards	EN 60950
EMC standards	EN 55011, EN 55022, EN 55024, EN 61000-6 /2, -3
Mounting position, installation notice	Panel mount, screw fix
Net weight	400 g
Approvals	CE; cURus; EAC
Connection cross-section, solid, min. / max.	0.34 / 4 mm ²
Depth x width x height	135 / 98.5 / 40 mm
Note	

Ordering data

Note	
-------------	--

Type	Qty.	Order No.
CP E SNT 75W 5V 12A	1	1202470000

Type	Qty.	Order No.
CP E SNT 75W 12V 6A	1	1202480000

Accessories

Note	
-------------	--

Note		
The internal varistor found in a switch-mode power supply does not replace the necessary surge protection in a system.		

Note		
The internal varistor found in a switch-mode power supply does not replace the necessary surge protection in a system.		

connectPower
PRO-E



CP E SNT 75W 24V 3.2A

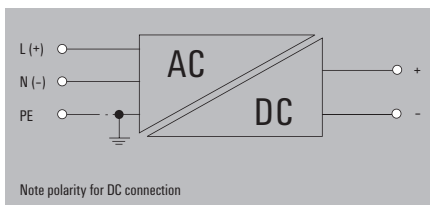

CP E SNT 75W 48V 1.6A

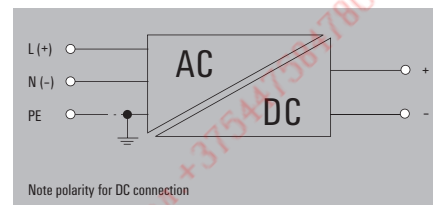

Technical data

Input	
Input voltage	
Input current	
Input frequency	
Input fuse (internal)	
Recommended back-up fuse	
Output	
Output voltage	
Output voltage adjustment	
Output current	
Output power	
Residual ripple, breaking spikes	
Overload protection	
Surge protection	
Mains failure bridge-over time	
Control at 10...100% load	
Parallel connection option	
Insulation coordination	
electrical isolation, output-earth	
electrical isolation, input-earth	
electrical isolation, input-output	
General data	
Ambient temperature (operational)	
Storage temperature	
Max. perm. air humidity (operational)	
Degree of efficiency	
Status indicator	
Standards	
EMC standards	
Mounting position, installation notice	
Net weight	
Approvals	
Screw connection	
Connection cross-section, solid, min. / max.	
Depth x width x height	
Note	

Input voltage	85...264 V AC / 110...370 V DC
Input current	1 A @ 230 V AC / 2 A @ 120 V AC
Input frequency	47...63 Hz
Input fuse (internal)	yes / max. 20A
Recommended back-up fuse	4 A at 230 V AC, characteristic curve C
Output voltage	24 V DC
Output voltage adjustment	± 10% nominal output voltage tolerance, adjustable with potentiometer
Output current	3.2 A@24 V DC
Output power	75 W
Residual ripple, breaking spikes	< 100 mV _{pp}
Overload protection	120~150% I _{konst.} of max. output power, automatic restart
Surge protection	28...32 V @ 24 V DC
Mains failure bridge-over time	20 ms
Control at 10...100% load	0.5%
Parallel connection option	Recommended with diode module
electrical isolation, output-earth	0.5 kV
electrical isolation, input-earth	1.5 kV
electrical isolation, input-output	3 kV
Ambient temperature (operational)	-20°C...70°C (>50°C derating, refer derated curve); 70% rated load@70°C
Storage temperature	-20 °C...85 °C
Max. perm. air humidity (operational)	5 %...95 % RH
Degree of efficiency	85 % @ 24 V DC
Status indicator	Operation, green LED
Standards	EN 60950
EMC standards	EN 55011, EN 55022, EN 55024, EN 61000-6 /-2, -3
Mounting position, installation notice	Panel mount, screw fix
Net weight	422 g
Approvals	CE; cURus; EAC
Connection cross-section, solid, min. / max.	0.34 / 4 mm ²
Depth x width x height	135 / 98.5 / 40 mm
Note	

Input voltage	85...264 V AC / 110...370 V DC
Input current	1 A @ 230 V AC / 2 A @ 120 V AC
Input frequency	47...63 Hz
Input fuse (internal)	yes / max. 20A
Recommended back-up fuse	4 A at 230 V AC, characteristic curve C
Output voltage	48 V DC
Output voltage adjustment	± 10% nominal output voltage tolerance, adjustable with potentiometer
Output current	1.6 A@48 V DC
Output power	75 W
Residual ripple, breaking spikes	< 100 mV _{pp}
Overload protection	120~150% I _{konst.} of max. output power, automatic restart
Surge protection	55...62 V @ 48 V DC
Mains failure bridge-over time	20 ms
Control at 10...100% load	0.5%
Parallel connection option	Recommended with diode module
electrical isolation, output-earth	0.5 kV
electrical isolation, input-earth	1.5 kV
electrical isolation, input-output	3 kV
Ambient temperature (operational)	-20°C...70°C (>50°C derating, refer derated curve); 70% rated load@70°C
Storage temperature	-20 °C...85 °C
Max. perm. air humidity (operational)	5 %...95 % RH
Degree of efficiency	86 % @ 48 V DC
Status indicator	Operation, green LED
Standards	EN 60950
EMC standards	EN 55011, EN 55022, EN 55024, EN 61000-6 /-2, -3
Mounting position, installation notice	Panel mount, screw fix
Net weight	408 g
Approvals	CE; cURus; EAC
Connection cross-section, solid, min. / max.	0.34 / 4 mm ²
Depth x width x height	135 / 98.5 / 40 mm
Note	

Ordering data

Type	Qty.	Order No.
CP E SNT 75W 24V 3.2A	1	1202490000

Type	Qty.	Order No.
CP E SNT 75W 48V 1.6A	1	1202510000

Note
The internal varistor found in a switch-mode power supply does not replace the necessary surge protection in a system.

Note
The internal varistor found in a switch-mode power supply does not replace the necessary surge protection in a system.

Accessories

Note

Note

connectPower PRO-E

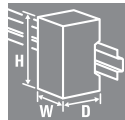

CP E SNT 100W 5V 16A

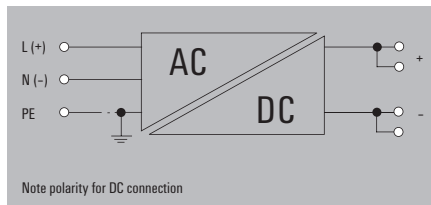

CP E SNT 100W 12V 8.5A

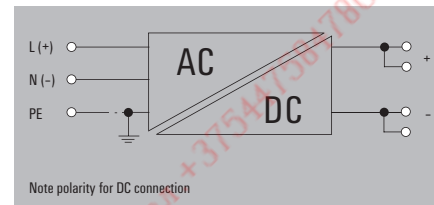

Technical data

Input	
Input voltage	
Input current	
Input frequency	
Input fuse (internal)	
Recommended back-up fuse	
Output	
Output voltage	
Output voltage adjustment	
Output current	
Output power	
Residual ripple, breaking spikes	
Overload protection	
Surge protection	
Mains failure bridge-over time	
Control at 10...100% load	
Parallel connection option	
Insulation coordination	
electrical isolation, output-earth	
electrical isolation, input-earth	
electrical isolation, input-output	
General data	
Ambient temperature (operational)	
Storage temperature	
Max. perm. air humidity (operational)	
Degree of efficiency	
Status indicator	
Standards	
EMC standards	
Mounting position, installation notice	
Net weight	
Approvals	
Screw connection	
Connection cross-section, solid, min. / max.	
Depth x width x height	
Note	

Input voltage	88...132 V AC / 176...264 V AC optional / 250...370 V DC
Input current	1.5 A @ 230 V AC / 3 A @ 120 V AC
Input frequency	47...63 Hz
Input fuse (internal)	yes / max. 20A
Recommended back-up fuse	4 A at 230 V AC, characteristic curve C
Output voltage	5 V DC
Output voltage adjustment	± 10% nominal output voltage tolerance, adjustable with potentiometer
Output current	16 A@5 V DC
Output power	100 W
Residual ripple, breaking spikes	< 100 mV _{pp}
Overload protection	120~150% I _{konst.} of max. output power, automatic restart
Surge protection	5.6...6.8 V @ 5 V DC
Mains failure bridge-over time	20 ms
Control at 10...100% load	0.5%
Parallel connection option	Recommended with diode module
electrical isolation, output-earth	0.5 kV
electrical isolation, input-earth	1.5 kV
electrical isolation, input-output	3 kV
Ambient temperature (operational)	-20°C...70°C (>50°C derating, refer derated curve); 70% rated load@70°C
Storage temperature	-20 °C...85 °C
Max. perm. air humidity (operational)	5 %...95 % RH
Degree of efficiency	77 % @ 5 V DC
Status indicator	Operation, green LED
Standards	EN 60950
EMC standards	EN 55011, EN 55022, EN 55024, EN 61000-6 /-2, -3
Mounting position, installation notice	Panel mount, screw fix
Net weight	551 g
Approvals	CE; cURus; EAC
Connection cross-section, solid, min. / max.	0.34 / 4 mm ²
Depth x width x height	164 / 97.5 / 40 mm
Note	

Input voltage	88...132 V AC / 176...264 V AC optional / 250...370 V DC
Input current	1.5 A @ 230 V AC / 3 A @ 120 V AC
Input frequency	47...63 Hz
Input fuse (internal)	yes / max. 20A
Recommended back-up fuse	4 A at 230 V AC, characteristic curve C
Output voltage	12 V DC
Output voltage adjustment	± 10% nominal output voltage tolerance, adjustable with potentiometer
Output current	8.5 A@12 V DC
Output power	100 W
Residual ripple, breaking spikes	< 100 mV _{pp}
Overload protection	120~150% I _{konst.} of max. output power, automatic restart
Surge protection	13.5...16.2 V @ 12 V DC
Mains failure bridge-over time	20 ms
Control at 10...100% load	0.5%
Parallel connection option	Recommended with diode module
electrical isolation, output-earth	0.5 kV
electrical isolation, input-earth	1.5 kV
electrical isolation, input-output	3 kV
Ambient temperature (operational)	-20°C...70°C (>50°C derating, refer derated curve); 70% rated load@70°C
Storage temperature	-20 °C...85 °C
Max. perm. air humidity (operational)	5 %...95 % RH
Degree of efficiency	81 % @ 12 V DC
Status indicator	Operation, green LED
Standards	EN 60950
EMC standards	EN 55011, EN 55022, EN 55024, EN 61000-6 /-2, -3
Mounting position, installation notice	Panel mount, screw fix
Net weight	548 g
Approvals	CE; cURus; EAC
Connection cross-section, solid, min. / max.	0.34 / 4 mm ²
Depth x width x height	164 / 97.5 / 40 mm
Note	

Ordering data

Type	Qty.	Order No.
CP E SNT 100W 5V 16A	1	1165820000

Type	Qty.	Order No.
CP E SNT 100W 12V 8.5A	1	1165830000

Note
The internal varistor found in a switch-mode power supply does not replace the necessary surge protection in a system.

Note
The internal varistor found in a switch-mode power supply does not replace the necessary surge protection in a system.

Accessories

Note

Note

connectPower
PRO-E

CP E SNT 100W 24V 4.5A

CP E SNT 100W 48V 2.3A

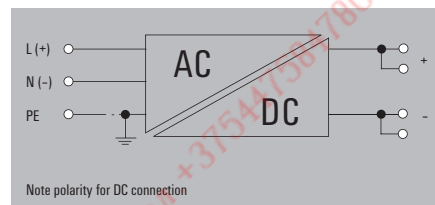
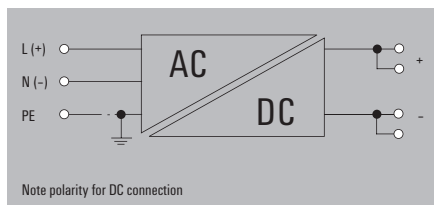
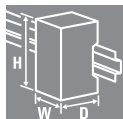

Technical data

Input	
Input voltage	
Input current	
Input frequency	
Input fuse (internal)	
Recommended back-up fuse	
Output	
Output voltage	
Output voltage adjustment	
Output current	
Output power	
Residual ripple, breaking spikes	
Overload protection	
Surge protection	
Mains failure bridge-over time	
Control at 10...100% load	
Parallel connection option	
Insulation coordination	
electrical isolation, output-earth	
electrical isolation, input-earth	
electrical isolation, input-output	
General data	
Ambient temperature (operational)	
Storage temperature	
Max. perm. air humidity (operational)	
Degree of efficiency	
Status indicator	
Standards	
EMC standards	
Mounting position, installation notice	
Net weight	
Approvals	
Screw connection	
Connection cross-section, solid, min. / max.	
Depth x width x height	
Note	

Input voltage	88...132 V AC / 176...264 V AC optional / 250...370 V DC
Input current	1.5 A @ 230 V AC / 3 A @ 120 V AC
Input frequency	47...63 Hz
Input fuse (internal)	yes / max. 20A
Recommended back-up fuse	4 A at 230 V AC, characteristic curve C
Output voltage	24 V DC
Output voltage adjustment	± 10% nominal output voltage tolerance, adjustable with potentiometer
Output current	4.5 A@24 V DC
Output power	100 W
Residual ripple, breaking spikes	< 100 mV _{pp}
Overload protection	120~150% I _{konst.} of max. output power, automatic restart
Surge protection	28...32 V @ 24 V DC
Mains failure bridge-over time	20 ms
Control at 10...100% load	0.5%
Parallel connection option	Recommended with diode module
electrical isolation, output-earth	0.5 kV
electrical isolation, input-earth	1.5 kV
electrical isolation, input-output	3 kV
Ambient temperature (operational)	-20°C...70°C (>50°C derating, refer derated curve); 70% rated load@70°C
Storage temperature	-20 °C...85 °C
Max. perm. air humidity (operational)	5 %...95 % RH
Degree of efficiency	85 % @ 24 V DC
Status indicator	Operation, green LED
Standards	EN 60950
EMC standards	EN 55011, EN 55022, EN 55024, EN 61000-6 /-2, -3
Mounting position, installation notice	Panel mount, screw fix
Net weight	527 g
Approvals	CE; cURus; EAC
Connection cross-section, solid, min. / max.	0.34 / 4 mm ²
Depth x width x height	164 / 97.5 / 40 mm
Note	

Input voltage	88...132 V AC / 176...264 V AC optional / 250...370 V DC
Input current	1.5 A @ 230 V AC / 3 A @ 120 V AC
Input frequency	47...63 Hz
Input fuse (internal)	yes / max. 20A
Recommended back-up fuse	4 A at 230 V AC, characteristic curve C
Output voltage	48 V DC
Output voltage adjustment	± 10% nominal output voltage tolerance, adjustable with potentiometer
Output current	2.3 A@48 V DC
Output power	100 W
Residual ripple, breaking spikes	< 100 mV _{pp}
Overload protection	120~150% I _{konst.} of max. output power, automatic restart
Surge protection	55...62 V @ 48 V DC
Mains failure bridge-over time	20 ms
Control at 10...100% load	0.5%
Parallel connection option	Recommended with diode module
electrical isolation, output-earth	0.5 kV
electrical isolation, input-earth	1.5 kV
electrical isolation, input-output	3 kV
Ambient temperature (operational)	-20°C...70°C (>50°C derating, refer derated curve); 70% rated load@70°C
Storage temperature	-20 °C...85 °C
Max. perm. air humidity (operational)	5 %...95 % RH
Degree of efficiency	86 % @ 48 V DC
Status indicator	Operation, green LED
Standards	EN 60950
EMC standards	EN 55011, EN 55022, EN 55024, EN 61000-6 /-2, -3
Mounting position, installation notice	Panel mount, screw fix
Net weight	556 g
Approvals	CE; cURus; EAC
Connection cross-section, solid, min. / max.	0.34 / 4 mm ²
Depth x width x height	164 / 97.5 / 40 mm
Note	

Ordering data

Type	Qty.	Order No.
CP E SNT 100W 24V 4.5A	1	1165840000

Type	Qty.	Order No.
CP E SNT 100W 48V 2.3A	1	1165850000

Note

The internal varistor found in a switch-mode power supply does not replace the necessary surge protection in a system.

The internal varistor found in a switch-mode power supply does not replace the necessary surge protection in a system.

Accessories

Note

connectPower PRO-E

connectPower PRO-E

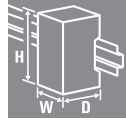

CP E SNT 150W 12V 12.5A

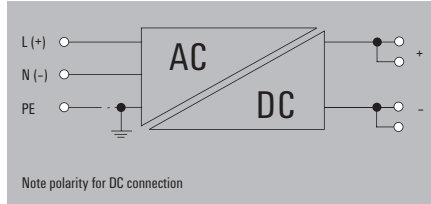

CP E SNT 150W 24V 6.5A

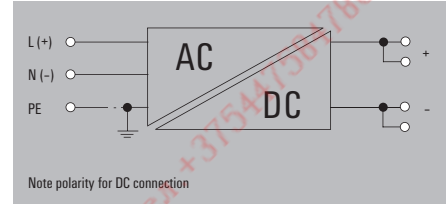

Technical data

Input	
Input voltage	
Input current	
Input frequency	
Input fuse (internal)	
Recommended back-up fuse	
Output	
Output voltage	
Output voltage adjustment	
Output current	
Output power	
Residual ripple, breaking spikes	
Overload protection	
Surge protection	
Mains failure bridge-over time	
Control at 10...100% load	
Parallel connection option	
Insulation coordination	
electrical isolation, output-earth	
electrical isolation, input-earth	
electrical isolation, input-output	
General data	
Ambient temperature (operational)	
Storage temperature	
Max. perm. air humidity (operational)	
Degree of efficiency	
Status indicator	
Standards	
EMC standards	
Mounting position, installation notice	
Net weight	
Approvals	
Screw connection	
Connection cross-section, solid, min. / max.	
Depth x width x height	
Note	

Input voltage	88...132 V AC / 176...264 V AC optional / 250...370 V DC
Input current	2 A @ 230 V AC / 3.5 A @ 120 V AC
Input frequency	47...63 Hz
Input fuse (internal)	yes / max. 35A
Recommended back-up fuse	4 A at 230 V AC, characteristic curve C
Output voltage	12 V DC
Output voltage adjustment	± 10% nominal output voltage tolerance, adjustable with potentiometer
Output current	12.5 A@12 V DC
Output power	150 W
Residual ripple, breaking spikes	< 100 mV _{pp}
Overload protection	120~150% I _{konst.} of max. output power, automatic restart
Surge protection	13.5...16.2 V @ 12 V DC
Mains failure bridge-over time	20 ms
Control at 10...100% load	0.5%
Parallel connection option	Recommended with diode module
electrical isolation, output-earth	0.5 kV
electrical isolation, input-earth	1.5 kV
electrical isolation, input-output	3 kV
Ambient temperature (operational)	-20°C...70°C (>50°C derating, refer derated curve); 70% rated load@70°C
Storage temperature	-20 °C...85 °C
Max. perm. air humidity (operational)	5 %...95 % RH
Degree of efficiency	82 % @ 12 V DC
Status indicator	Operation, green LED
Standards	EN 60950
EMC standards	EN 55011, EN 55022, EN 55024, EN 61000-6 /-2, -3
Mounting position, installation notice	Panel mount, screw fix
Net weight	680 g
Approvals	CE; cURus; EAC
Connection cross-section, solid, min. / max.	0.34 / 4 mm ²
Depth x width x height	205 / 99 / 40 mm
Note	

Input voltage	88...132 V AC / 176...264 V AC optional / 250...370 V DC
Input current	2 A @ 230 V AC / 3.5 A @ 120 V AC
Input frequency	47...63 Hz
Input fuse (internal)	yes / max. 35A
Recommended back-up fuse	4 A at 230 V AC, characteristic curve C
Output voltage	24 V DC
Output voltage adjustment	± 10% nominal output voltage tolerance, adjustable with potentiometer
Output current	6.5 A@24 V DC
Output power	150 W
Residual ripple, breaking spikes	< 100 mV _{pp}
Overload protection	120~150% I _{konst.} of max. output power, automatic restart
Surge protection	28...32 V @ 24 V DC
Mains failure bridge-over time	20 ms
Control at 10...100% load	0.5%
Parallel connection option	Recommended with diode module
electrical isolation, output-earth	0.5 kV
electrical isolation, input-earth	1.5 kV
electrical isolation, input-output	3 kV
Ambient temperature (operational)	-20°C...70°C (>50°C derating, refer derated curve); 70% rated load@70°C
Storage temperature	-20 °C...85 °C
Max. perm. air humidity (operational)	5 %...95 % RH
Degree of efficiency	86 % @ 24 V DC
Status indicator	Operation, green LED
Standards	EN 60950
EMC standards	EN 55011, EN 55022, EN 55024, EN 61000-6 /-2, -3
Mounting position, installation notice	Panel mount, screw fix
Net weight	682 g
Approvals	CE; cURus; EAC
Connection cross-section, solid, min. / max.	0.34 / 4 mm ²
Depth x width x height	205 / 99 / 40 mm
Note	

Ordering data

Note	
-------------	--

Type	Qty.	Order No.
CP E SNT 150W 12V 12.5A	1	1165870000

Type	Qty.	Order No.
CP E SNT 150W 24V 6.5A	1	1165880000

Accessories

Note	
-------------	--

Note		
The internal varistor found in a switch-mode power supply does not replace the necessary surge protection in a system.		

Note		
The internal varistor found in a switch-mode power supply does not replace the necessary surge protection in a system.		

**connectPower
PRO-E**

CP E SNT 150W 48V 3.3A

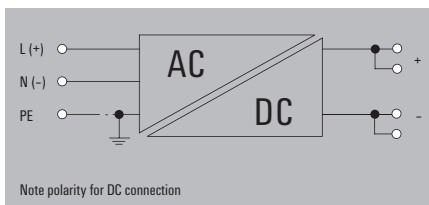

Technical data

Input	
Input voltage	Input voltage 88...132 V AC / 176...264 V AC optional / 250...370 V DC
Input current	2 A @ 230 V AC / 3.5 A @ 120 V AC
Input frequency	47...63 Hz
Input fuse (internal)	yes / max. 35A
Recommended back-up fuse	4 A at 230 V AC, characteristic curve C
Output	
Output voltage	48 V DC
Output voltage adjustment	± 10% nominal output voltage tolerance, adjustable with potentiometer
Output current	3.3 A @ 48 V DC
Output power	150 W
Residual ripple, breaking spikes	< 100 mV _{pp}
Overload protection	120~150% lkonst. of max. output power, automatic restart
Surge protection	55...62 V @ 48 V DC
Mains failure bridge-over time	20 ms
Control at 10...100% load	0.5%
Parallel connection option	Recommended with diode module
Insulation coordination	
electrical isolation, output-earth	0.5 kV
electrical isolation, input-earth	1.5 kV
electrical isolation, input-output	3 kV
General data	
Ambient temperature (operational)	Ambient temperature (operational) -20°C...70°C (>50°C derating, refer derated curve); 70% rated load @ 70°C
Storage temperature	-20 °C...85 °C
Max. perm. air humidity (operational)	5 %...95 % RH
Degree of efficiency	87 % @ 48 V DC
Status indicator	Operation, green LED
Standards	EN 60950
EMC standards	EN 55011, EN 55022, EN 55024, EN 61000-6 /2, -3
Mounting position, installation notice	Panel mount, screw fix
Net weight	685 g
Approvals	CE; cURus; EAC
Screw connection	
Connection cross-section, solid, min. / max.	0.34 / 4 mm ²
Depth x width x height	205 / 99 / 40 mm
Note	

Ordering data

Type	Qty.	Order No.
CP E SNT 150W 48V 3.3A	1	1165890000

Note

The internal varistor found in a switch-mode power supply does not replace the necessary surge protection in a system.

Accessories

Note

connectPower PRO-E

connectPower PRO-E

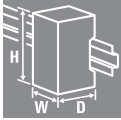

CP E SNT 250W 12V 21A

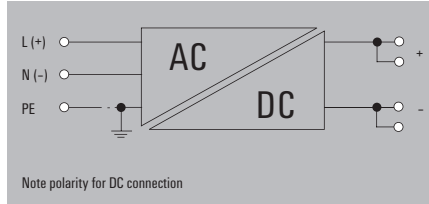

CP E SNT 250W 24V 10.5A

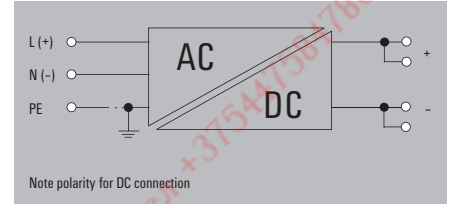

Technical data

Input	
Input voltage	
Input current	
Input frequency	
Input fuse (internal)	
Recommended back-up fuse	
Output	
Output voltage	
Output voltage adjustment	
Output current	
Output power	
Residual ripple, breaking spikes	
Overload protection	
Surge protection	
Mains failure bridge-over time	
Control at 10...100% load	
Parallel connection option	
Insulation coordination	
electrical isolation, output-earth	
electrical isolation, input-earth	
electrical isolation, input-output	
General data	
Ambient temperature (operational)	
Storage temperature	
Max. perm. air humidity (operational)	
Degree of efficiency	
Status indicator	
Standards	
EMC standards	
Mounting position, installation notice	
Net weight	
Approvals	
Screw connection	
Connection cross-section, solid, min. / max.	
Depth x width x height	
Note	

Input voltage	88...132 V AC / 176...264 V AC optional / 250...370 V DC
Input current	2.5 A @ 230 V AC / 4.7 A @ 120 V AC
Input frequency	47...63 Hz
Input fuse (internal)	yes / max. 35A
Recommended back-up fuse	6 A at 230 V AC, characteristic curve C
Output voltage	12 V DC
Output voltage adjustment	± 10% nominal output voltage tolerance, adjustable with potentiometer
Output current	21 A @ 12 V DC
Output power	250 W
Residual ripple, breaking spikes	< 100 mV _{pp}
Overload protection	120~150% I _{konst.} of max. output power, automatic restart
Surge protection	13.5...16.2 V @ 12 V DC
Mains failure bridge-over time	20 ms
Control at 10...100% load	0.5%
Parallel connection option	Recommended with diode module
electrical isolation, output-earth	0.5 kV
electrical isolation, input-earth	1.5 kV
electrical isolation, input-output	3 kV
Ambient temperature (operational)	-20°C...70°C (>50°C derating, refer derated curve); 70% rated load @ 70°C
Storage temperature	-20 °C...85 °C
Max. perm. air humidity (operational)	5 %...95 % RH
Degree of efficiency	80 % @ 12 V DC
Status indicator	Operation, green LED
Standards	EN 60950
EMC standards	EN 55011, EN 55022, EN 55024, EN 61000-6 /-2, -3
Mounting position, installation notice	Panel mount, screw fix
Net weight	1000 g
Approvals	CE; cURus; EAC
Connection cross-section, solid, min. / max.	0.34 / 4 mm ²
Depth x width x height	231 / 115 / 49.5 mm
Note	

Input voltage	88...132 V AC / 176...264 V AC optional / 250...370 V DC
Input current	2.5 A @ 230 V AC / 4.7 A @ 120 V AC
Input frequency	47...63 Hz
Input fuse (internal)	yes / max. 35A
Recommended back-up fuse	6 A at 230 V AC, characteristic curve C
Output voltage	24 V DC
Output voltage adjustment	± 10% nominal output voltage tolerance, adjustable with potentiometer
Output current	10.5 A @ 24 V DC
Output power	250 W
Residual ripple, breaking spikes	< 100 mV _{pp}
Overload protection	120~150% I _{konst.} of max. output power, automatic restart
Surge protection	28...32 V @ 24 V DC
Mains failure bridge-over time	20 ms
Control at 10...100% load	0.5%
Parallel connection option	Recommended with diode module
electrical isolation, output-earth	0.5 kV
electrical isolation, input-earth	1.5 kV
electrical isolation, input-output	3 kV
Ambient temperature (operational)	-20°C...70°C (>50°C derating, refer derated curve); 70% rated load @ 70°C
Storage temperature	-20 °C...85 °C
Max. perm. air humidity (operational)	5 %...95 % RH
Degree of efficiency	81 % @ 24 V DC
Status indicator	Operation, green LED
Standards	EN 60950
EMC standards	EN 55011, EN 55022, EN 55024, EN 61000-6 /-2, -3
Mounting position, installation notice	Panel mount, screw fix
Net weight	1022 g
Approvals	CE; cURus; EAC
Connection cross-section, solid, min. / max.	0.34 / 4 mm ²
Depth x width x height	231 / 115 / 49.5 mm
Note	

Ordering data

Type	Qty.	Order No.
CP E SNT 250W 12V 21A	1	1202520000

Type	Qty.	Order No.
CP E SNT 250W 12V 21A	1	1202520000

Type	Qty.	Order No.
CP E SNT 250W 24V 10.5A	1	1202530000

Note

The internal varistor found in a switch-mode power supply does not replace the necessary surge protection in a system.

Note

The internal varistor found in a switch-mode power supply does not replace the necessary surge protection in a system.

Note

The internal varistor found in a switch-mode power supply does not replace the necessary surge protection in a system.

Accessories

Note

Note

Note

**connectPower
PRO-E**

CP E SNT 250W 48V 5.2A

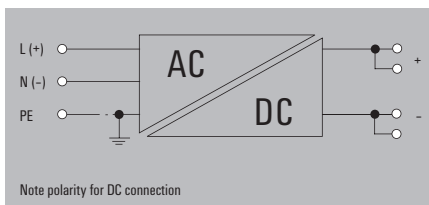

Technical data

Input	
Input voltage	
Input current	
Input frequency	
Input fuse (internal)	
Recommended back-up fuse	
Output	
Output voltage	
Output voltage adjustment	
Output current	
Output power	
Residual ripple, breaking spikes	
Overload protection	
Surge protection	
Mains failure bridge-over time	
Control at 10...100% load	
Parallel connection option	
Insulation coordination	
electrical isolation, output-earth	
electrical isolation, input-earth	
electrical isolation, input-output	
General data	
Ambient temperature (operational)	
Storage temperature	
Max. perm. air humidity (operational)	
Degree of efficiency	
Status indicator	
Standards	
EMC standards	
Mounting position, installation notice	
Net weight	
Approvals	
Screw connection	
Connection cross-section, solid, min. / max.	
Depth x width x height	
Note	

Input voltage	88...132 V AC / 176...264 V AC optional / 250...370 V DC
Input current	2.5 A @ 230 V AC / 4.7 A @ 120 V AC
Input frequency	47...63 Hz
Input fuse (internal)	yes / max. 35A
Recommended back-up fuse	6 A at 230 V AC, characteristic curve C
Output voltage	48 V DC
Output voltage adjustment	± 10% nominal output voltage tolerance, adjustable with potentiometer
Output current	5.2 A@48 V DC
Output power	250 W
Residual ripple, breaking spikes	< 100 mV _{pp}
Overload protection	120~150% lkonst. of max. output power, automatic restart
Surge protection	55...62 V @ 48 V DC
Mains failure bridge-over time	20 ms
Control at 10...100% load	0.5%
Parallel connection option	Recommended with diode module
electrical isolation, output-earth	0.5 kV
electrical isolation, input-earth	1.5 kV
electrical isolation, input-output	3 kV
Ambient temperature (operational)	-20°C...70°C (>50°C derating, refer derated curve); 70% rated load@70°C
Storage temperature	-20 °C...85 °C
Max. perm. air humidity (operational)	5 %...95 % RH
Degree of efficiency	83 % @ 48 V DC
Status indicator	Operation, green LED
Standards	EN 60950
EMC standards	EN 55011, EN 55022, EN 55024, EN 61000-6 /-2, -3
Mounting position, installation notice	Panel mount, screw fix
Net weight	1078 g
Approvals	CE; cURus; EAC
Connection cross-section, solid, min. / max.	0.34 / 4 mm ²
Depth x width x height	231 / 115 / 49.5 mm
Note	

Ordering data

Type	Qty.	Order No.
CP E SNT 250W 48V 5.2A	1	1202540000

Note	
-------------	--

The internal varistor found in a switch-mode power supply does not replace the necessary surge protection in a system.

Accessories

Note	
-------------	--

connectPower PRO-E

connectPower PRO-E

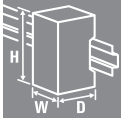

CP E SNT 350W 24V 14.6A

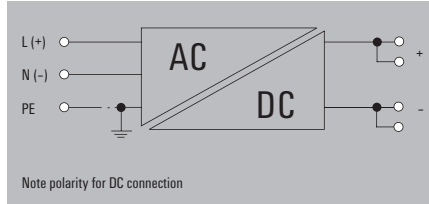

CP E SNT 350W 48V 7.3A

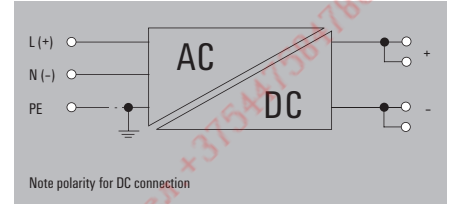

Technical data

Input	
Input voltage	
Input current	
Input frequency	
Input fuse (internal)	
Recommended back-up fuse	
Output	
Output voltage	
Output voltage adjustment	
Output current	
Output power	
Residual ripple, breaking spikes	
Overload protection	
Surge protection	
Mains failure bridge-over time	
Control at 10...100% load	
Parallel connection option	
Insulation coordination	
electrical isolation, output-earth	
electrical isolation, input-earth	
electrical isolation, input-output	
General data	
Ambient temperature (operational)	
Storage temperature	
Max. perm. air humidity (operational)	
Degree of efficiency	
Status indicator	
Standards	
EMC standards	
Mounting position, installation notice	
Net weight	
Approvals	
Screw connection	
Connection cross-section, solid, min. / max.	
Depth x width x height	
Note	

Input voltage	85...264 V AC / 110...370 V DC
Input current	3 A @ 230 V AC / 5.6 A @ 120 V AC
Input frequency	47...63 Hz
Input fuse (internal)	yes / max. 35A
Recommended back-up fuse	6 A at 230 V AC, characteristic curve C
Output voltage	24 V DC
Output voltage adjustment	± 10% nominal output voltage tolerance, adjustable with potentiometer
Output current	14.6 A@24 V DC
Output power	350 W
Residual ripple, breaking spikes	
Overload protection	120~150% Ikonst. of max. output power, automatic restart
Surge protection	28...32 V @ 24 V DC
Mains failure bridge-over time	20 ms
Control at 10...100% load	0.5%
Parallel connection option	Recommended with diode module
electrical isolation, output-earth	0.5 kV
electrical isolation, input-earth	1.5 kV
electrical isolation, input-output	3 kV
Ambient temperature (operational)	-20°C...70°C (>50°C derating, refer derated curve); 70% rated load@70°C
Storage temperature	-20 °C...85 °C
Max. perm. air humidity (operational)	5 %...95 % RH
Degree of efficiency	83 % @ 24 V DC
Status indicator	Operation, green LED
Standards	EN 60950
EMC standards	EN 55011, EN 55022, EN 55024, EN 61000-6 /2, -3
Mounting position, installation notice	Panel mount, screw fix
Net weight	1030 g
Approvals	CE; cURus; EAC
Connection cross-section, solid, min. / max.	0.34 / 4 mm ²
Depth x width x height	230 / 115 / 49.5 mm
Note	

Input voltage	85...264 V AC / 110...370 V DC
Input current	3 A @ 230 V AC / 5.6 A @ 120 V AC
Input frequency	47...63 Hz
Input fuse (internal)	yes / max. 35A
Recommended back-up fuse	6 A at 230 V AC, characteristic curve C
Output voltage	48 V DC
Output voltage adjustment	± 10% nominal output voltage tolerance, adjustable with potentiometer
Output current	7.3 A@48 V DC
Output power	350 W
Residual ripple, breaking spikes	
Overload protection	120~150% Ikonst. of max. output power, automatic restart
Surge protection	55...62 V @ 48 V DC
Mains failure bridge-over time	20 ms
Control at 10...100% load	0.5%
Parallel connection option	Recommended with diode module
electrical isolation, output-earth	0.5 kV
electrical isolation, input-earth	1.5 kV
electrical isolation, input-output	3 kV
Ambient temperature (operational)	-20°C...70°C (>50°C derating, refer derated curve); 70% rated load@70°C
Storage temperature	-20 °C...85 °C
Max. perm. air humidity (operational)	5 %...95 % RH
Degree of efficiency	85 % @ 48 V DC
Status indicator	Operation, green LED
Standards	EN 60950
EMC standards	EN 55011, EN 55022, EN 55024, EN 61000-6 /2, -3
Mounting position, installation notice	Panel mount, screw fix
Net weight	1051 g
Approvals	CE; cURus; EAC
Connection cross-section, solid, min. / max.	0.34 / 4 mm ²
Depth x width x height	230 / 115 / 49.5 mm
Note	

Ordering data

Type	Qty.	Order No.
CP E SNT 350W 24V 14.6A	1	1202550000

Type	Qty.	Order No.
CP E SNT 350W 24V 14.6A	1	1202550000

Type	Qty.	Order No.
CP E SNT 350W 48V 7.3A	1	1202560000

Note

The internal varistor found in a switch-mode power supply does not replace the necessary surge protection in a system.

The internal varistor found in a switch-mode power supply does not replace the necessary surge protection in a system.

The internal varistor found in a switch-mode power supply does not replace the necessary surge protection in a system.

Accessories

Note

Note

г. Минск www.fotorele.net www.tiristor.by email minsk17@tut.by тел. +375447584780

Installation drawing

CP E SNT 25W

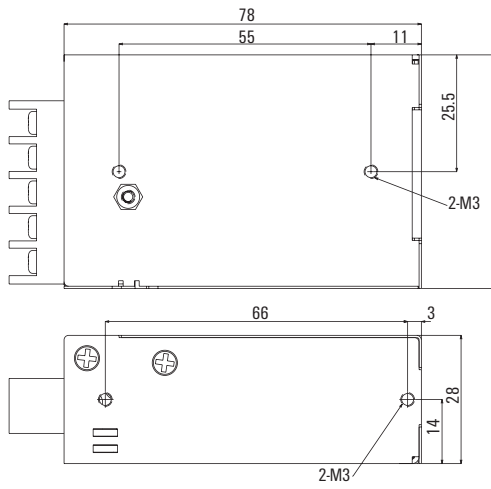

CP E SNT 50W

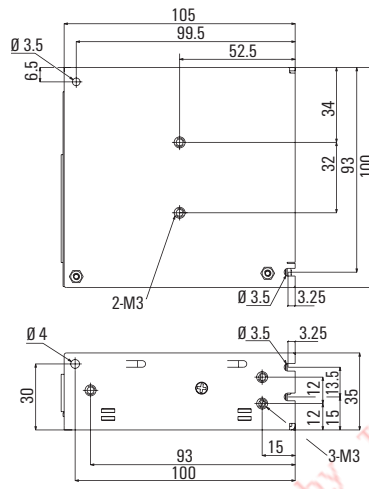

CP E SNT 75W

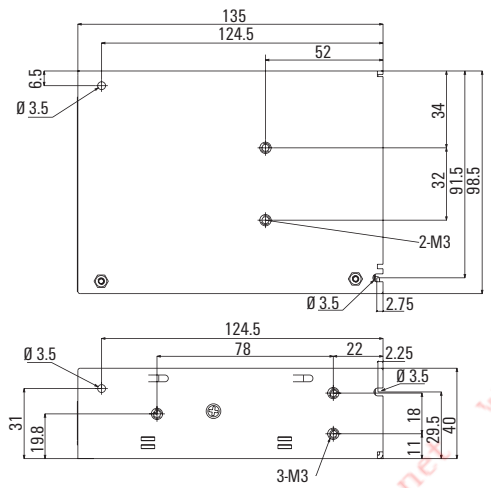

CP E SNT 100W

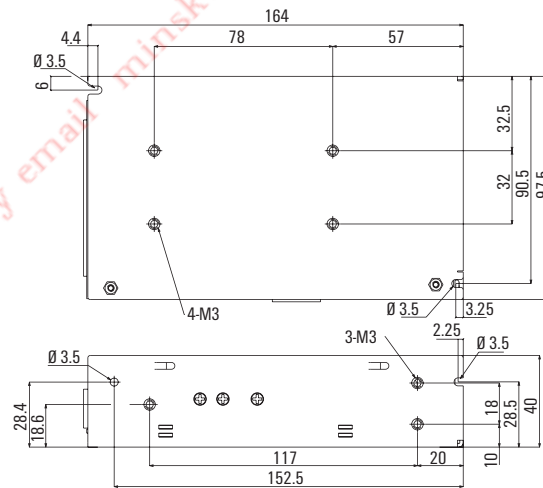

CP E SNT 150W

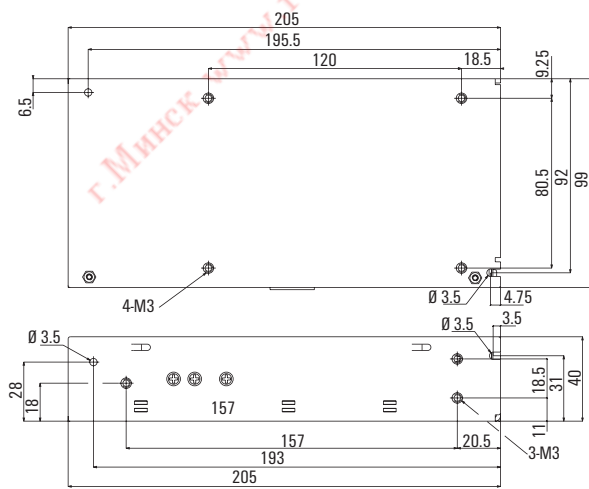

Installation drawing

CP E SNT 250W and CP E SNT 350W

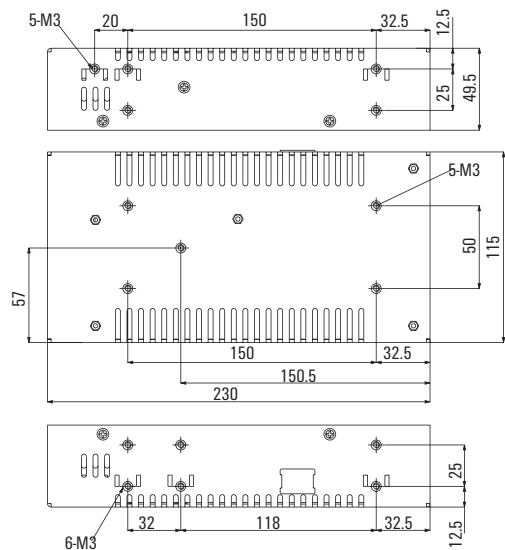

CP E SNT 250W and CP E SNT 350W (with mounting clip)

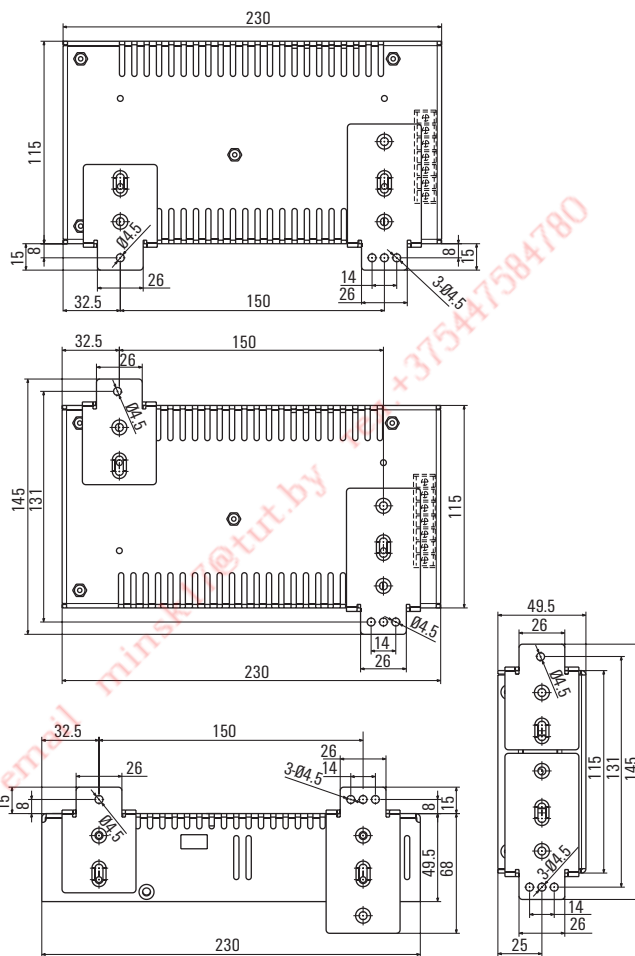

CP-E-SNT derating curve / ambient temperature

CP E SNT 25W up to CP E SNT 350W

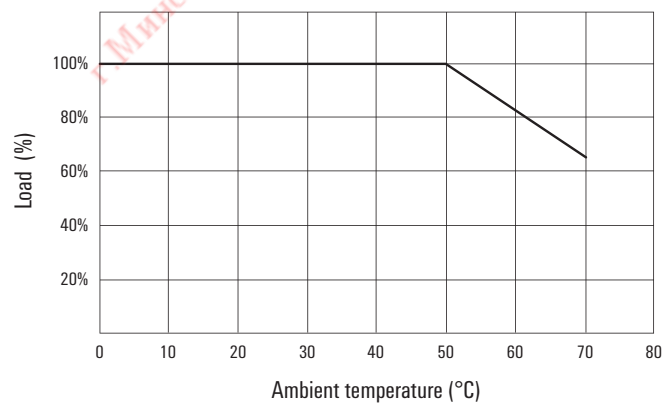

connectPower
Single-phase

CP SNT 25W 5V 5A

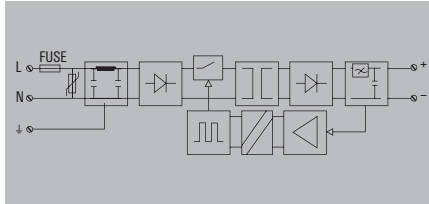
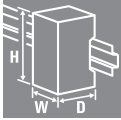

Technical data

Input	
Input voltage	85...264 V AC / 110...370 V DC
Input current	500 mA at rated load @ 230 V AC
Input frequency	50/ 60 Hz
Overload current protection	Yes
Input fuse	Fusible link 2.5 A (T) / 250 V

Output	
Output voltage	4...8 V DC (adjustable via potentiometer)
Output current	5 A
Output power	25 W
Max. residual ripple	120 mV _{SS}
Overload protection	105 %...150 % I _{const} of max. output load; automatic reset

Surge protection	Varistor
Mains failure bridge-over time	11 ms @ 115 V AC / 50 ms @ 230 V AC
Control at 10...100% load	1%
Max. capacitance at output	10000 µF

Insulation coordination (EN 50178)	
electrical isolation, output-earth	0.5 kV
electrical isolation, input-earth	1.5 kV
electrical isolation, input-output	3 kV
electrical isolation, I/O rail	4 kV

General data	
Ambient temperature (operational)	-10...70 °C (Derating ab 55 °C)
Storage temperature	-20 °C...85 °C
Degree of efficiency at max. load	70%
Standards	DIN EN 50178 (PELV), DIN EN 60950 (SELV)
Approvals	cCSAus; cURus; EAC; UL
EMC standards	EN 55011, EN 55022, EN 61000-3-2,-3, EN 61000-6-2,-3,-4
Parallel connection option	Max. 3 devices (rated voltages are to be calibrated at ±20 mV)

Dimensions	
Clamping range (nominal / min. / max.)	mm ²
Depth x width x height	mm

Note	
------	--

Input	
Input voltage	85...264 V AC / 110...370 V DC
Input current	500 mA at rated load @ 230 V AC
Input frequency	50/ 60 Hz
Overload current protection	Yes
Input fuse	Fusible link 2.5 A (T) / 250 V

Output	
Output voltage	4...8 V DC (adjustable via potentiometer)
Output current	5 A
Output power	25 W
Max. residual ripple	120 mV _{SS}
Overload protection	105 %...150 % I _{const} of max. output load; automatic reset

Surge protection	Varistor
Mains failure bridge-over time	11 ms @ 115 V AC / 50 ms @ 230 V AC
Control at 10...100% load	1%
Max. capacitance at output	10000 µF

Insulation coordination (EN 50178)	
electrical isolation, output-earth	0.5 kV
electrical isolation, input-earth	1.5 kV
electrical isolation, input-output	3 kV
electrical isolation, I/O rail	4 kV

General data	
Ambient temperature (operational)	-10...70 °C (Derating ab 55 °C)
Storage temperature	-20 °C...85 °C
Degree of efficiency at max. load	70%
Standards	DIN EN 50178 (PELV), DIN EN 60950 (SELV)
Approvals	cCSAus; cURus; EAC; UL
EMC standards	EN 55011, EN 55022, EN 61000-3-2,-3, EN 61000-6-2,-3,-4
Parallel connection option	Max. 3 devices (rated voltages are to be calibrated at ±20 mV)

Input / Output	
Clamping range (nominal / min. / max.)	mm ²
Depth x width x height	mm

Note	
------	--

Ordering data

Screw connection

Type	Qty.	Order No.
CP SNT 25W 5V 5A	1	8754960000

Note	
------	--

The internal varistor found in a switch-mode power supply does not replace the necessary surge protection in a system.

Accessories

Note	
------	--

Derating curve

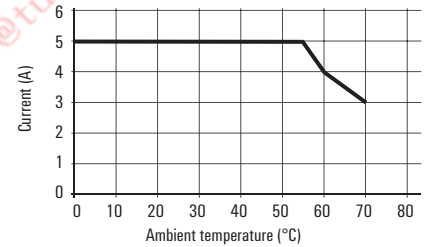

connectPower
Single-phase

CP SNT 48W 12V 4A

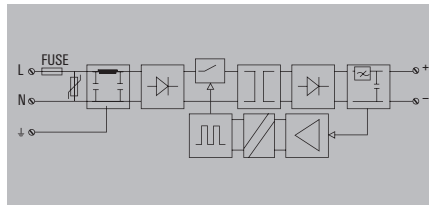
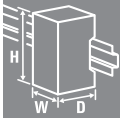

Technical data

Input

Input voltage
Input current
Input frequency
Overload current protection
Input fuse

85...264 V AC / 110...370 V DC
500 mA at rated load @ 230 V AC
50/ 60 Hz
Yes
Fusible link 2.5 A (T) / 250 V

Output

Output voltage
Output current
Output power
Max. residual ripple
Overload protection

9...15 V DC (adjustable via potentiometer)
4 A
48 W
120 mV_{SS}
105 %...150 % I_{const} of max. output load; automatic reset

Surge protection
Mains failure bridge-over time
Control at 10...100% load
Max. capacitance at output

Varistor
11 ms @ 115 V AC / 50 ms @ 230 V AC
1%
10000 µF

Insulation coordination (EN 50178)

electrical isolation, output-earth
electrical isolation, input-earth
electrical isolation, input-output
electrical isolation, I/O rail

0.5 kV
1.5 kV
3 kV
4 kV

General data

Ambient temperature (operational)
Storage temperature
Degree of efficiency at max. load
Standards
Approvals
EMC standards
Parallel connection option

-10...70 °C (Derating ab 55 °C)
-20 °C...85 °C
75%
DIN EN 50178 (PELV), DIN EN 60950 (SELV)
cCSAus; CE; cURus; EAC; UL
EN 55011, EN 55022, EN 61000-3-2,-3, EN 61000-6-2,-3,-4
Max. 3 devices (rated voltages are to be calibrated at ±20 mV)

Derating curve

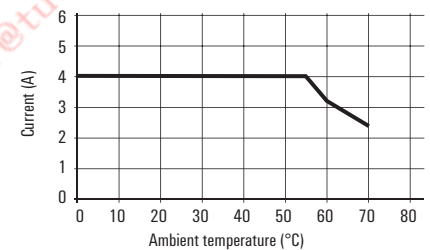

Dimensions

Clamping range (nominal / min. / max.) mm²
Depth x width x height mm

Input / Output

2.5 / 0.5 / 4
62.5 / 70 / 90.5

Note

Ordering data

Screw connection

Type	Qty.	Order No.
CP SNT 48W 12V 4A	1	8754970000

Note

The internal varistor found in a switch-mode power supply does not replace the necessary surge protection in a system.

Accessories

Note

connectPower
Single-phase

CP SNT 48W 24V 2A

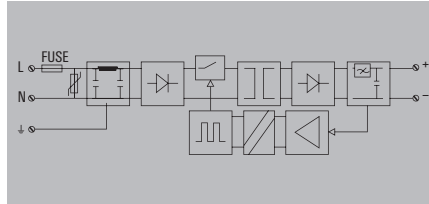
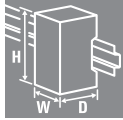

Technical data

Input	
Input voltage	85...264 V AC / 110...370 V DC
Input current	500 mA at rated load @ 230 V AC
Input frequency	50/ 60 Hz
Overload current protection	Yes
Input fuse	Fusible link 2.5 A (T) / 250 V
Output	
Output voltage	15...28 V DC (adjustable via potentiometer)
Output current	2 A
Output power	48 W
Max. residual ripple	120 mV _{SS}
Overload protection	105 %...150 % I _{const} of max. output load; automatic reset
Surge protection	
Mains failure bridge-over time	11 ms @ 115 V AC / 50 ms @ 230 V AC
Control at 10...100% load	1%
Max. capacitance at output	10000 µF
Insulation coordination (EN 50178)	
electrical isolation, output-earth	0.5 kV
electrical isolation, input-earth	1.5 kV
electrical isolation, input-output	3 kV
electrical isolation, I/O rail	4 kV
General data	
Ambient temperature (operational)	-10...70 °C (Derating ab 55 °C)
Storage temperature	-20 °C...85 °C
Degree of efficiency at max. load	78%
Standards	DIN EN 50178 (PELV), DIN EN 60950 (SELV)
Approvals	cCSAus; cURus; EAC; UL
EMC standards	EN 55011, EN 55022, EN 61000-3-2,-3, EN 61000-6-2,-3,-4
Parallel connection option	Max. 3 devices (rated voltages are to be calibrated at ±20 mV)

Derating curve

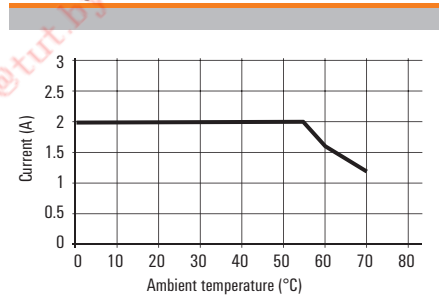

Dimensions	
Clamping range (nominal / min. / max.)	mm ²
Depth x width x height	mm
Note	

Input / Output	
2.5 / 0.5 / 4	
62.5 / 70 / 90.5	
Note	

Ordering data

Screw connection

Type	Qty.	Order No.
CP SNT 48W 24V 2A	1	8739140000

Note

The internal varistor found in a switch-mode power supply does not replace the necessary surge protection in a system.

Accessories

Note

connectPower
Single-phase

CP SNT 48W 48V 1A

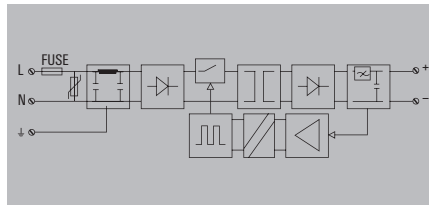
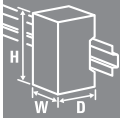

Technical data

Input

Input voltage
Input current
Input frequency
Overload current protection
Input fuse

85...264 V AC / 110...370 V DC
500 mA at rated load @ 230 V AC
50/ 60 Hz
Yes
Fusible link 2.5 A (T) / 250 V

Output

Output voltage
Output current
Output power
Max. residual ripple
Overload protection

46...55 V DC (adjustable via potentiometer)
1 A
48 W
120 mV_{SS}
105 %...150 % I_{const} of max. output load; automatic reset

Surge protection
Mains failure bridge-over time
Control at 10...100% load
Max. capacitance at output

Varistor
11 ms @ 115 V AC / 50 ms @ 230 V AC
1%
10000 µF

Insulation coordination (EN 50178)

electrical isolation, output-earth
electrical isolation, input-earth
electrical isolation, input-output
electrical isolation, I/O rail

0.5 kV
1.5 kV
3 kV
4 kV

General data

Ambient temperature (operational)
Storage temperature
Degree of efficiency at max. load
Standards
Approvals
EMC standards
Parallel connection option

-10...70 °C (Derating ab 55 °C)
-20 °C...85 °C
80%
DIN EN 50178 (PELV), DIN EN 60950 (SELV)
cCSAus; cURus; EAC; UL
EN 55011, EN 55022, EN 61000-3-2,-3, EN 61000-6-2,-3,-4
Max. 3 devices (rated voltages are to be calibrated at ±20 mV)

Derating curve

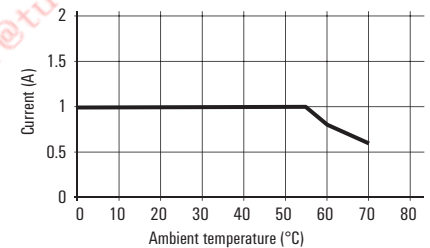

Dimensions

Clamping range (nominal / min. / max.) mm²
Depth x width x height mm

Input / Output

2.5 / 0.5 / 4
62.5 / 70 / 90.5

Note

Ordering data

Screw connection

Type	Qty.	Order No.
CP SNT 48W 48V 1A	1	8879230000

Note

The internal varistor found in a switch-mode power supply does not replace the necessary surge protection in a system.

Accessories

Note

Small screwdriver



Type	Blade type	Size/AF	a	b	c	Order No.
SDIK PH1		1.00			80	9008570000
SDIS 0.5X3.0X100	B		0.5	3	100	9008380000

Markers

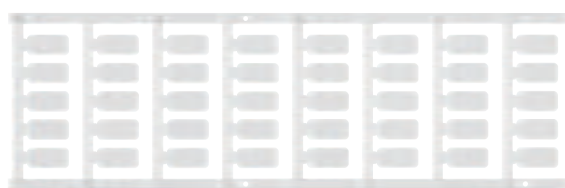

Type	Colour	Qty.	Order No.
SM 18/9.5 K MC NE WS	white	200	1248580000

End bracket

For DIN rail TS 35



Polyamide with fibre glass, screwable	Colour	Torque	Qty.	Order No.
WEW 35/1 SW	black	1.2 Nm	50	1162600000

г. Минск www.fotorele.net www.tiristor.by email minsk17@tut.by тел. +375447584780

г. Минск www.fotorele.net www.tiristor.by email minsk17@tut.by тел. +375447584780

connectPower DC/DC converter

ConnectPower DC/DC converter



Derating curve

Event	Input	Output	LED (Gr/Ye/Rd)		Transistor status outputs			Status relay
			LED (Gr/Ye/Rd) gr = "DC OK" Ye = "i > 90% I _N " Rd = "FAul T"	LED (Ye) "i low u _N "	DC OK	i > 90% I _N	i low u _N	
U _N < 14 V	-	-	OFF	ON	Low	Low	Low	OFF
U _N = 14...19.2 V *)	I < 90% I _N	I > 90% I _N	Gr	ON	High	Low	Low	ON
			Ye	ON	High	High	Low	ON
U _N > 19.2 V	I < 90% I _N	I > 90% I _N	Rd	ON	Low	Low	Low	OFF
			Gr	OFF	High	Low	High	ON
U _N > 19.2 V	I < 90% I _N	I > 90% I _N	Ye	OFF	High	High	High	ON
			Rd	OFF	Low	Low	High	OFF

Gr = grün / green / verde / verde / verde / verde / 绿色
 Ye = gelb / yellow / jaune / giallo / amarillo / amarillo / 黄色
 Rd = rot / red / rouge / rosso / rojo / vermelho / 红色
 *) während des Betriebes / during operations / en cours de fonctionnement / durante l'esercizio / durante el servicio / durante a operação / 运行过程中

Signal states

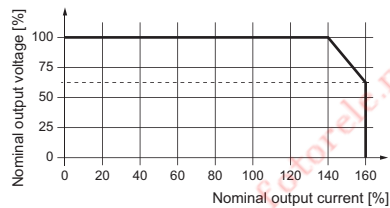
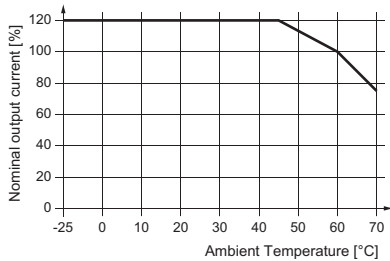

Technical data

General data	
Current limiting	150% I _{out}
Insulation voltage input / earth	1.5
Insulation voltage output / earth	0.5
Insulation voltage, input/output	1.5
Ambient temperature (operational) / Storage temperature / Start-up	-25 °C...70 °C / -40 °C...85 °C / ≥ -40 °C
Humidity at operating temperature	5...95 %, no condensation
Class of protection / Pollution degree	III, with no ground connection, for SELV / 2
MTBF	1250000
Housing version	Metal, corrosion resistant
Mounting position, installation notice	Horizontal on TS35 mounting rail. 50 mm of clearance at top & bottom for air circ. Can mount side by side with no space in between., 50 mm clearance at top and bottom for free air circulation, mountable side by side without clearance
EMC / shock / vibration	
Interference immunity test acc. to	EN 61000-4-2 (ESD), EN 61000-4-4 (burst), EN 61000-4-5 (surge), EN 61000-4-6 (conducted), EN61000-4-3 (HF field)
Shock	30 g in all directions
Resistance to vibration	2.3 g (15 Hz...150 Hz)
Electrical safety (applied standards)	
Electrical machine equipment	Acc. to EN60204
Safety transformers for switch-mode power supplies	nach EN61558-2-16
For use with electronic equipment	Acc. to EN50178 / VDE0160
Safety extra-low voltage	SELV acc. to EN60950, PELV acc. to EN60204
Protective separation / protection against electrical shock	VDE0100-410 / acc. to DIN57100-410
Protection against dangerous shock currents	Acc. to VDE0106-101

ConnectPower DC/DC converter

PRO DCDC 120W 24V 5A

PRO DCDC 240W 24V 10A

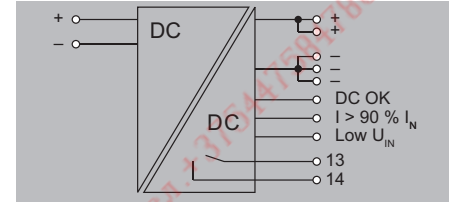
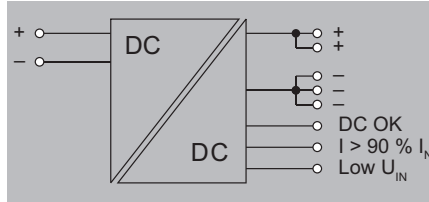

Technical data

Input	
Rated input voltage	24 V DC
DC input voltage range	14...32 V (during operation), 18...32 V (commissioning)
Input fuse (internal)	Yes
Inrush current / Overload current protection	Max. 10 A / Yes
Recommended back-up fuse	10 A, char. B circuit breaker, 10 A, char. C circuit breaker

Output	
Rated output voltage	24 V DC ± 1 %
Output voltage	22.5...29.5 V (adjustable via potentiometer on front)
Continuous output current @ U _{Rated}	5 A @ 60 °C, 6 A @ 45 °C, 3,75 A @ 70 °C
Output power	120
Ramp-up time	≤ 9 ms (U _{out} : 10%...90%)
Capacitive load	unrestricted
Parallel connection option	Yes, max. 5 (without diode module)
Leitungsreserve @ U _{Rated}	600% IN for 16 ms
Residual ripple, breaking spikes	max. 20 mVpp @ 24 VDC, IN
Protection against inverse voltage / Overload protection	Yes / Yes

General data	
AC failure bridging time @ I _{nom}	> 10 ms @ 24 V DC
Protection against reverse voltages from the load	33...34 V DC
Start-up	≥ -40 °C
Current limiting	150% I _{out}
Power loss idling / nominal load	2 W / 11 W
Degree of efficiency	typ. 92 %

Signalling	
Transistor output, positive-switching	DC OK: 20 mA max., short-circuit-proof, I > 90%: 20 mA max., short-circuit-proof, Low U _{IN} : 20 mA max., short-circuit-proof

Floating contact	Yes
Relay on/off / Contact load	Output voltage > 21.6 V / < 20.4 V / max. 30 V DC / 0.5 A

Approvals	
Approvals	ABS; BURVER; cULus; cULusEX; DNVGL; LLOYDSREG; RINA

Connection data	
Connection system	Screw connection: pluggable
Number of terminals	2 for (+, -)
Wire cross-section, rigid min/max	0.2 / 4 mm ²
Wire cross-section, flexible min/max	0.2 / 4 mm ²
Wire cross-section, AWG/kcmil min/max	30 / 12
Tightening torque	0.4 / 0.5

Note	

Ordering data

Type	Qty.	Order No.
PRO DCDC 120W 24V 5A	1	2001800000

Note	

Input	
Rated input voltage	24 V DC
DC input voltage range	14...32 V (during operation), 18...32 V (commissioning)
Input fuse (internal)	Yes
Inrush current / Overload current protection	Max. 10 A / Yes
Recommended back-up fuse	10 A, char. B circuit breaker, 10 A, char. C circuit breaker

Output	
Rated output voltage	24 V DC ± 1 %
Output voltage	22.5...29.5 V (adjustable via potentiometer on front)
Continuous output current @ U _{Rated}	5 A @ 60 °C, 6 A @ 45 °C, 3,75 A @ 70 °C
Output power	120
Ramp-up time	≤ 9 ms (U _{out} : 10%...90%)
Capacitive load	unrestricted
Parallel connection option	Yes, max. 5 (without diode module)
Leitungsreserve @ U _{Rated}	600% IN for 16 ms
Residual ripple, breaking spikes	max. 20 mVpp @ 24 VDC, IN
Protection against inverse voltage / Overload protection	Yes / Yes

General data	
AC failure bridging time @ I _{nom}	> 10 ms @ 24 V DC
Protection against reverse voltages from the load	33...34 V DC
Start-up	≥ -40 °C
Current limiting	150% I _{out}
Power loss idling / nominal load	2 W / 11 W
Degree of efficiency	typ. 92 %

Signalling	
Transistor output, positive-switching	DC OK: 20 mA max., short-circuit-proof, I > 90%: 20 mA max., short-circuit-proof, Low U _{IN} : 20 mA max., short-circuit-proof

Floating contact	Yes
Relay on/off / Contact load	Output voltage > 21.6 V / < 20.4 V / max. 30 V DC / 0.5 A

Approvals	
Approvals	ABS; BURVER; cULus; cULusEX; DNVGL; LLOYDSREG; RINA

Connection data	
Connection system	Screw connection: pluggable
Number of terminals	2 for (+, -)
Wire cross-section, rigid min/max	0.2 / 4 mm ²
Wire cross-section, flexible min/max	0.2 / 4 mm ²
Wire cross-section, AWG/kcmil min/max	30 / 12
Tightening torque	0.4 / 0.5

Note	

Type	Qty.	Order No.
PRO DCDC 120W 24V 5A	1	2001800000

Note	

Input	
Rated input voltage	24 V DC
DC input voltage range	14...32 V (during operation), 18...32 V (commissioning)
Input fuse (internal)	Yes
Inrush current / Overload current protection	max. 15 A / Yes
Recommended back-up fuse	25 A, Char.B circuit breaker, 25 A, Char.C circuit breaker

Output	
Rated output voltage	24 V DC ± 1 %
Output voltage	22.5...29.5 V (adjustable via potentiometer on front)
Continuous output current @ U _{Rated}	10 A @ 60 °C, 12 A @ 45 °C, 7,5 A @ 70 °C
Output power	240
Ramp-up time	≤ 9 ms (U _{out} : 10%...90%)
Capacitive load	unrestricted
Parallel connection option	Yes, max. 5 (without diode module)
Leitungsreserve @ U _{Rated}	600% IN for 16 ms
Residual ripple, breaking spikes	max. 20 mVpp @ 24 VDC, IN
Protection against inverse voltage / Overload protection	Yes / Yes

General data	
AC failure bridging time @ I _{nom}	> 12 ms @ 24 V DC
Protection against reverse voltages from the load	33...34 V DC
Start-up	≥ -40 °C
Current limiting	150% I _{out}
Power loss idling / nominal load	2 W / 22 W
Degree of efficiency	typ. 92 %

Signalling	
Transistor output, positive-switching	DC OK: 20 mA max., short-circuit-proof, I > 90%: 20 mA max., short-circuit-proof, Low U _{IN} : 20 mA max., short-circuit-proof

Floating contact	Yes
Relay on/off / Contact load	Output voltage > 21.6 V / < 20.4 V / max. 30 V DC / 0.5 A

Approvals	
Approvals	ABS; BURVER; cULus; cULusEX; DNVGL; LLOYDSREG; RINA

Connection data	
Connection system	Screw connection: pluggable
Number of terminals	2 for (+, -)
Wire cross-section, rigid min/max	0.08 / 4 mm ²
Wire cross-section, flexible min/max	0.08 / 4 mm ²
Wire cross-section, AWG/kcmil min/max	30 / 12
Tightening torque	0.4 / 0.5

Note	

Type	Qty.	Order No.
PRO DCDC 240W 24V 10A	1	2001810000

Note	

connectPower DC/DC converter

ConnectPower DC/DC converter

PRO DCDC 480W 24V 20A

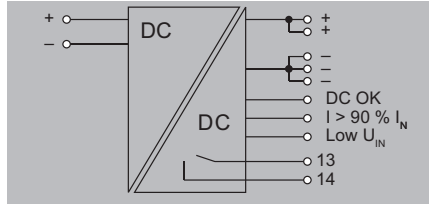

Technical data

Input
Rated input voltage
DC input voltage range
Input fuse (internal)
Inrush current / Overload current protection
Recommended back-up fuse

24 V DC
14...32 V (during operation), 18...32 V (commissioning)
Yes
max. 30 A / Yes
40 A, Char. B circuit breaker, 40 A, Char. C circuit breaker

Output
Rated output voltage
Output voltage
Continuous output current @ U_{Rated}
Output power
Ramp-up time
Capacitive load
Parallel connection option
Leitungsreserve @ U_{Rated}
Residual ripple, breaking spikes
Protection against inverse voltage / Overload protection

24 V DC \pm 1 %
22.5...29.5 V (adjustable via potentiometer on front)
20 A @ 60 °C, 24 A @ 45°C, 15 A @ 70°C
480
\leq 9 ms (U_{out} : 10%...90%)
unrestricted
yes, max. 3
600% IN for 16 ms
max. 20 mVpp @ 24 VDC, IN
Yes / Yes

General data
AC failure bridging time @ I_{Nom}
Protection against reverse voltages from the load
Start-up
Current limiting
Power loss idling / nominal load
Degree of efficiency

> 10 ms @ 24 V DC
33...34 V DC
\geq -40 °C
150% I_{out}
3 W / 40 W
typ. > 93%

Signalling
Transistor output, positive-switching

DC OK: 20 mA max., short-circuit-proof, I > 90%: 20 mA max., short-circuit-proof, Low U_{IN} : 20 mA max., short-circuit-proof
--

Floating contact
Relay on/off / Contact load

Yes
Output voltage > 21.6 V / < 20.4 V / max. 30 V DC / 0.5 A

Approvals
Approvals

ABS; BURVER; cULus; cULusEX; DNVGL; LLOYDSREG; RINA

Connection data	
Connection system	
Number of terminals	
Wire cross-section, rigid min/max	mm ²
Wire cross-section, flexible min/max	mm ²
Wire cross-section, AWG/kcmil min/max	
Tightening torque	

Input	Output
Screw connection	
2 for (+, -)	10 (+ / - / signal)
0.5 / 16	0.18 / 6
0.5 / 16	0.18 / 6
22 / 8	26 / 10
1.2 / 1.5	0.4 / 0.5

Note

Ordering data

Type	Qty.	Order No.
PRO DCDC 480W 24V 20A	1	2001820000

Note

Uninterruptible power supplies (UPS)

Uninterruptible power supplies (UPS)	Overview	B.2
	UPS control unit	B.4
	Battery modules	B.6
	Buffer modules	B.8

г. Минск www.fotorele.net www.tiristor.by email minsk17@tut.by тел. +375447584780

B

Uninterruptible power supplies

Weidmüller's uninterruptible power supplies reliably protect 24 V DC consumers from voltage drop-outs and dips, such as those that could occur as a result of mains faults. These products therefore play a key role in increasing systems availability.

The buffer module is the perfect solution for bridging short-term power supply failures or dips of up to 100 ms. The capacitor-based technology enables maintenance-free operation, depending on the application, of up to 10 years.

The UPS control unit, together with the accompanying battery module and the power supply, form a complete DC UPS system with support times in minutes or hours. The modular construction allows for the overall load to be distributed into non-safe and safe load circuits, such that often a smaller UPS can be designed.

A huge variety of operating types are available to suit the particular application precisely. A remote input to block battery operation, as well as multiple signal outputs, enable remote operation of the UPS.

UPS with battery module

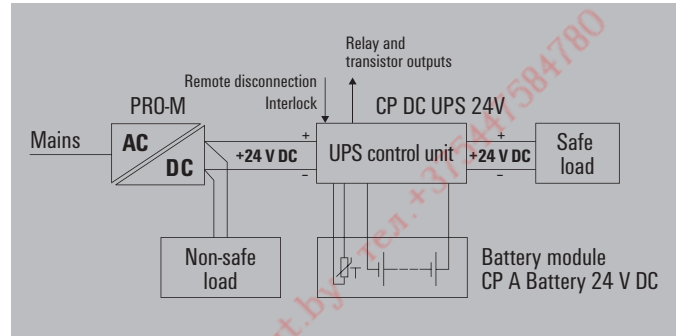

UPS with buffer module

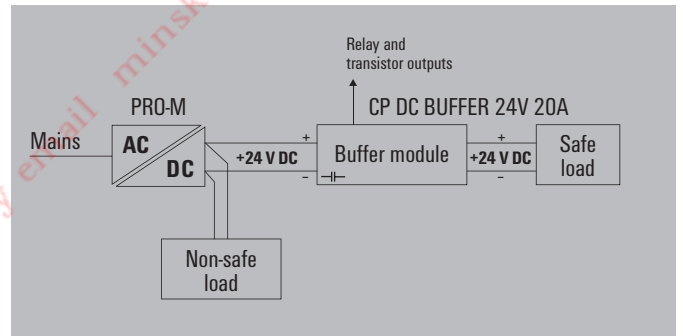

Can your facility afford to experience a power failure? Allow us to connect you so that you are safe from failure and downtime.

Let's connect.

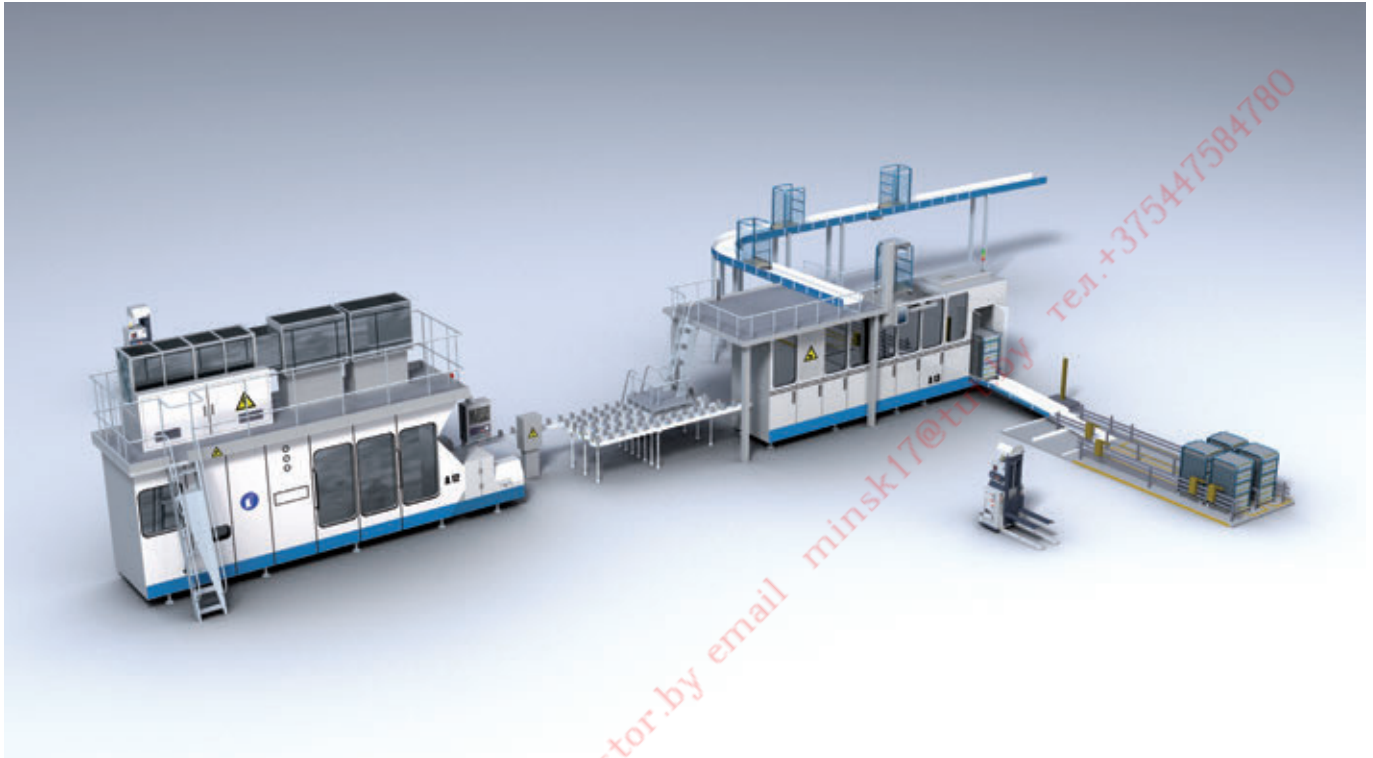

It is critical to safeguard a facility's power supply in the event of an outage. You cannot do without the important signals from the field, which serve to control the entire process. In addition, you also need to monitor a whole range of functions and performance parameters for your facility. Our highly modular power supply concept will support you in the practical fulfilment of all your requirements. At the same time, we will also familiarise ourselves with your future requirements and provide you with an individual, tailor-made solution, with components that are precisely aligned to work with one another.

For a continual, lasting power supply and clean control voltage, we use redundant circuits, selective short-circuit solutions, battery reservoirs and DC/DC converters. And because lightning and power surges can put an uninterrupted power supply in a production facility at risk, we also provide lightning and overvoltage protection. The VPU series provides unrestricted operation of power supplies and automation devices such as sensors, actuators and control units. The subsequent availability of the power supply means that all devices will restart in a controlled manner. Let's connect.



PROmax

- Used to save space in automation technology
- Individual modulation of the output power
- Up to 5 devices can be switched directly, in parallel
- Optional diode modules with fault signalling
- Expanded temperature range -25 °C to 70 °C

UPS control unit

- Different status relays for status monitoring
- Direct switchover to battery operation in the event of malfunction
- Automatic reconnection to load when power recovers
- Long battery life due to integrated deep discharge protection
- Optimised charging feature

UPS control unit

- Two 24 V models in 10 A/20 A and 40 A
- Temperature-compensated charging feature for long battery life
- Integrated battery diagnostics including continuous availability test
- Status relay and additional transistor outputs for remote monitoring
- Convenient LED displays for easy error analysis



Technical data

Indication	
Status relay (max.load 30 V AC/DC 0.1 A)	Fault (alarm), battery operation (buff.), charging (charg.)
Transistor outputs (24 to 27 V DC max. load 150 mA)	Fault (alarm), battery operation (buff.), charging (charg.)
LED status indicator	Three-colour LED: battery capacities > 85 % green, > 40 % yellow, > 20 % red, < 20 % red (flashing) Green/yellow LED: normal / buffering Yellow/red LED: temperature alarm / alarm Yellow/red LED: switch-off / battery fault
General technical data	
Ambient temperature (operational)	-25 °C...+70 °C
Storage temperature	-40 °C...+85 °C
Max. perm. air humidity	5...95 %
Protection degree	IP 20
Class of protection	3
Pollution severity level	2
Overvoltage category	III
Insulation voltage input/output to housing/ground	1300 V DC 1 min (typetest)
MTBF	> 500,000 hours acc. to IEC 1709
Protection against reverse voltages from the load	32...34 V DC
Parallel connection option	Yes, only with diode module for redundancy
Housing version	Metal, corrosion resistant
Mounting position, installation notice	Horizontal on mounting rail TS 35, 50 mm above and below Space for free movement of air
Overload protection	Yes
Short-circuit protection	Yes
EMC / shock / vibration	
Interference emission	Acc. to EN55022 Class B
Interference immunity tests	Acc. to EN61000-4-2 (ESD), EN61000-4-3 and EN61000-4-8 (fields), EN61000-4-4 (burst), EN61000-4-5 (surge), EN61000-4-6 (conducted), EN61000-4-11 (dips)
Resistance against vibration and shock	Acc. to IEC60954 Vibration: 2.3 g, Acc. to IEC60068-2-31 shock: 30 g in all directions
Electrical safety (applied standards)	
Electrical equipment of machines	Acc. to EN60204
Safety transformers for switch-mode power supplies	Acc. to EN61558-2-16
Machinery with electronic equipment	Acc. to EN50178 / VDE0160
Extra-low voltage protection	SELV acc. to EN60950, PLEV acc. to EN60204

Blockschaltbild

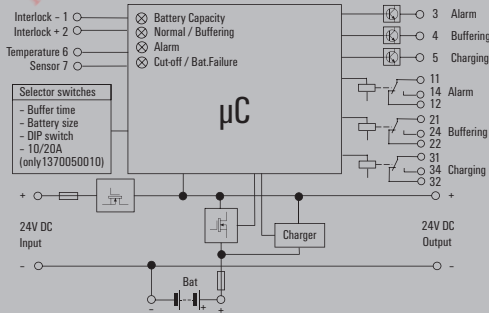

Verdrahtung

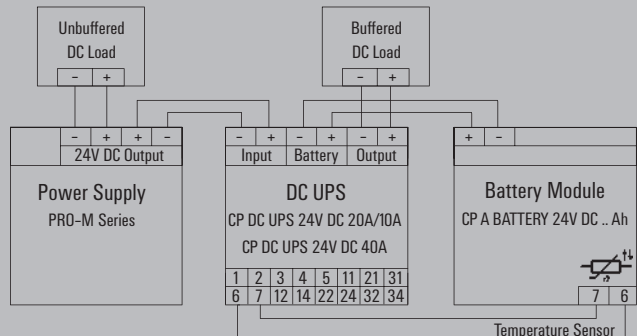

UPS control unit



Technical data

Input	
Rated input voltage	24 V DC
DC input voltage range	20...30 V DC
Input current	≤ 13A (for 10A), ≤ 23A (for 20A)
Input fuse (internal)	Yes
DC current consumption	max. 200 mA (without battery), max. 0.5 A (with fully charged battery)
Reverse polarity protection	Yes
Output	
Rated output voltage	24 V DC ± 1 %
Output voltage	$V_o = V_{in} - 0.2 \text{ V}$ normal operation (I _{max}), $V_o = V_{in} - 0.3 \text{ V}$ battery operation (I _{max})
Rated (nominal) output current @ U _{Nom}	20 A @ 60 °C
Continuous output current	
Power boost	
Integrated battery charger	
Charging feature	IU characteristic curve
Charging voltage (temperature compensated)	27, 48 V @ 20°C
Temperature coefficient	- 48 mV / °C
Charging current	0.15 CA
Battery availability test	every minute
Battery module	
Rated voltage	24 V
Storage medium	1.3 Ah, 3.4 Ah, 7.2 Ah, 12 Ah, 17 Ah, Selectable with rotary switch
Parallel connection option	yes, max 2.
Operating elements and control inputs	
Output current selector switch	20 A, 10 A
Selector switch battery	1.3 Ah, 3.4 Ah, 7.2 Ah, 12 Ah, 17 Ah, No Battery, Service
Selector switch buffer times	0.5 min, 1 min, 3 min, 5 min, 10 min, 20 min, 30 min, 45 min, ∞, ∞ w/D
DIP switch	Inversion of transistor outputs, Operation without temperature probe
Remote disconnection (Interlock)	Yes
Temperature probe	NTC 100 kΩ
General data	
Buffer times	Depending on the connected battery
Degree of efficiency	≥ 96% normal mode, battery is being charged, ≥ 98% normal mode, battery is charged, ≥ 98% buffer mode
Power loss	< 10 W
Depth x width x height / Net weight	/ 150 / 66 / 130 mm / 1146 Kg
Approvals	
Approvals	CE; cULus; EAC; GL

Connection data	
Wire connection method	Screw connection
Wire cross-section, rigid min/max	0.5 / 16
Wire cross-section, flexible min/max	0.5 / 16
Wire cross-section, AWG/kcmil min/max	26 / 6
Tightening torque	1.2...1.5
Note	

Ordering data

Type	Qty.	Order No.
CP DC UPS 24V 20A/10A	1	1370050010
Note		

CP DC UPS 24V 20A/10A



Input/output/battery		Signal
Screw connection		Screw connection
0.5 / 16		0.5 / 16
0.5 / 16		0.5 / 16
26 / 6		26 / 12
1.2...1.5		

Type	Qty.	Order No.
CP DC UPS 24V 20A/10A	1	1370050010
Note		

CP DC UPS 24V 40A



Input	
Rated input voltage	20...30 V DC
DC input voltage range	≤ 43 A
Input current	≤ 43 A
Input fuse (internal)	Yes
DC current consumption	max. 200 mA (without battery), max. 0.5 A (with fully charged battery)
Reverse polarity protection	Yes
Output	
Rated output voltage	24 V DC ± 1 %
Output voltage	$V_o = V_{in} - 0.2 \text{ V}$ normal operation (I _{max}), $V_o = V_{in} - 0.3 \text{ V}$ battery operation (I _{max})
Rated (nominal) output current @ U _{Nom}	40 A @ 60 °C
Continuous output current	
Power boost	
Integrated battery charger	
Charging feature	IU characteristic curve
Charging voltage (temperature compensated)	27, 48 V @ 20°C
Temperature coefficient	- 48 mV / °C
Charging current	0.15 CA
Battery availability test	every minute
Battery module	
Rated voltage	24 V
Storage medium	3.4 Ah, 7.2 Ah, 12 Ah, 17 Ah, Selectable with rotary switch
Parallel connection option	yes, max 2.
Operating elements and control inputs	
Output current selector switch	3.4 Ah, 7.2 Ah, 12 Ah, 17 Ah, No Battery, Service
Selector switch battery	0.5 min, 1 min, 3 min, 5 min, 10 min, 20 min, 30 min, 45 min, ∞, ∞ w/D
Selector switch buffer times	0.5 min, 1 min, 3 min, 5 min, 10 min, 20 min, 30 min, 45 min, ∞, ∞ w/D
DIP switch	Inversion of transistor outputs, Operation without temperature probe
Remote disconnection (Interlock)	Yes
Temperature probe	NTC 100 kΩ
General data	
Buffer times	Depending on the connected battery
Degree of efficiency	≥ 96% normal mode, battery is being charged, ≥ 98% normal mode, battery is charged, ≥ 98% buffer mode
Power loss	< 10 W
Depth x width x height / Net weight	/ 150 / 66 / 130 mm / 1051.8 Kg
Approvals	
Approvals	CE; cULus; EAC; GL

Input/output/battery		Signal
Screw connection		Screw connection
0.5 / 16		0.5 / 16
0.5 / 16		0.5 / 16
26 / 6		26 / 12
1.2...1.5		

Type	Qty.	Order No.
CP DC UPS 24V 40A	1	1370040010
Note		

Battery modules

Battery modules

- Maintenance-free lead-acid batteries from 3.4 Ah to 17 Ah
- Integrated temperature sensor for optimal battery charging
- Capacity up to 40 A / 30 min or 1 A / 30 hrs
- Robust metal housing for wall mounting

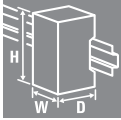

CP A BATTERY 24V DC1.3AH



CP A BATTERY 24V DC3.4AH

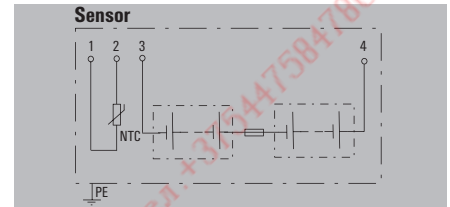
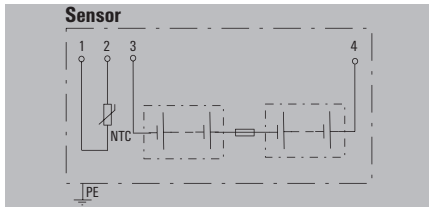

Technical data

Rated input voltage	24 V DC
Nominal capacity	1.3 Ah
Charging current, max.	0.2 A
Overload and short circuit protection	15 A fuse
Buffer time 1QA	3 min
Buffer time 2QA	
Output current, max.	15 A
Parallel connection option	Yes
Series switching capability	No
Temperature probe	NTC 100 kΩ
General data	
Battery type	Maintenance-free AGM lead-acid battery
Operating life	6...9 years @ 20°C
Ambient temperature	0°...+40°C (Charging); -15°...+50°C (Discharging)
Storage temperature	-15 °C...40 °C
Latest commissioning	9 months
Max. perm. air humidity (operational)	5 %...95 % RH
Class of protection	III, with no ground connection, for SELV
Protection degree	IP20
Vibration DIN rail/wall in accordance with IEC 68-2-6	0.7 / 0.7 g
Shock wall acc. to IEC 68227	30 g
Depth x width x height / Net weight	/ 124 / 52 / 148 mm / 1650 Kg
Approvals	cULus; EAC; GL

Rated input voltage	24 V DC
Nominal capacity	3.4 Ah
Charging current, max.	0.51 A
Overload and short circuit protection	25 A fuse
Buffer time 1QA	11.3 min
Buffer time 2QA	5 min
Output current, max.	25 A
Parallel connection option	Yes
Series switching capability	No
Temperature probe	NTC 100 kΩ
General data	
Battery type	Maintenance-free AGM lead-acid battery
Operating life	6...9 years @ 20°C
Ambient temperature	0°...+40°C (Charging); -15°...+50°C (Discharging)
Storage temperature	-15 °C...40 °C
Latest commissioning	9 months
Max. perm. air humidity (operational)	5 %...95 % RH
Class of protection	III, with no ground connection, for SELV
Protection degree	IP20
Vibration DIN rail/wall in accordance with IEC 68-2-6	0.7 / 0.7 g
Shock wall acc. to IEC 68227	30 g
Depth x width x height / Net weight	/ 137 / 108 / 144 mm / 10 Kg
Approvals	cULus; EAC; GL

Rated input voltage	24 V DC
Nominal capacity	3.4 Ah
Charging current, max.	0.51 A
Overload and short circuit protection	25 A fuse
Buffer time 1QA	11.3 min
Buffer time 2QA	5 min
Output current, max.	25 A
Parallel connection option	Yes
Series switching capability	No
Temperature probe	NTC 100 kΩ
General data	
Battery type	Maintenance-free AGM lead-acid battery
Operating life	6...9 years @ 20°C
Ambient temperature	0°...+40°C (Charging); -15°...+50°C (Discharging)
Storage temperature	-15 °C...40 °C
Latest commissioning	9 months
Max. perm. air humidity (operational)	5 %...95 % RH
Class of protection	III, with no ground connection, for SELV
Protection degree	IP20
Vibration DIN rail/wall in accordance with IEC 68-2-6	0.7 / 0.7 g
Shock wall acc. to IEC 68227	30 g
Depth x width x height / Net weight	/ 137 / 108 / 144 mm / 10 Kg
Approvals	cULus; EAC; GL

Connection data	
Wire connection method	
Wire cross-section, rigid min/max	mm ²
Wire cross-section, flexible min/max	mm ²
Wire cross-section, AWG/kcmil min/max	
Tightening torque	Nm
Note	

Input/output/battery		Signal	
		Pluggable screw connection	
0.2 / 4		0.2 / 4	
0.2 / 4		0.2 / 4	
30 / 12		30 / 12	
0.5...0.5			

Input/output/battery		Signal	
		Pluggable screw connection	
0.2 / 6		0.2 / 1.5	
0.5 / 6		0.2 / 1.5	
22 / 10		28 / 16	
0.5...0.6			

Ordering data

Type	Qty.	Order No.
CP A BATTERY 24V DC1.3AH	1	1406930000

Type	Qty.	Order No.
CP A BATTERY 24V DC1.3AH	1	1406930000

Type	Qty.	Order No.
CP A BATTERY 24V DC3.4AH	1	1251070000

Note

Note

Note

Accessories

Note

Note

Note

CP A BATTERY 24V DC7.2AH

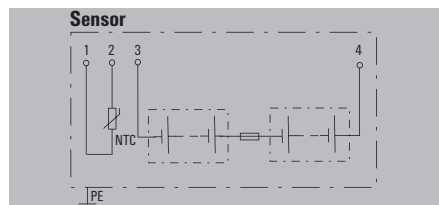

24 V DC
7.2 Ah
1.08 A
2x25 A fuse
26.5 min
11.5 min
50 A
Yes
No
NTC 100 kΩ
Maintenance-free AGM lead-acid battery
9...12 years @ 20°C
0°...+40°C (Charging); -15°...+50°C (Discharging)
-15 °C...40 °C
9 months
5 %...95 % RH
III, with no ground connection, for SELV
IP20
- / 0.7 g
30 g
/ 134 / 162 / 155 mm / 6250 Kg
cULus; EAC; GL

Input/output/battery	Signal
	Pluggable screw connection
0.2 / 16	0.2 / 1.5
0.5 / 16	0.2 / 1.5
22 / 6	28 / 16
1.2...1.5	

Type	Qty.	Order No.
CP A BATTERY 24V DC7.2AH	1	1251080000

CP A BATTERY 24V DC12AH

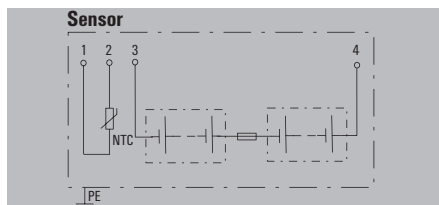

24 V DC
12 Ah
1.8 A
2x25 A fuse
51 min
22.7 min
50 A
Yes
No
NTC 100 kΩ
Maintenance-free AGM lead-acid battery
6...9 years @ 20°C
0°...+40°C (Charging); -15°...+50°C (Discharging)
-15 °C...40 °C
9 months
5 %...95 % RH
III, with no ground connection, for SELV
IP20
- / 0.7 g
30 g
/ 134 / 229 / 155 mm / 9120 Kg
cULus; EAC; GL

Input/output/battery	Signal
	Pluggable screw connection
0.2 / 16	0.2 / 1.5
0.5 / 16	0.2 / 1.5
22 / 6	28 / 16
1.2...1.5	

Type	Qty.	Order No.
CP A BATTERY 24V DC12AH	1	1251090000

CP A BATTERY 24V DC17AH

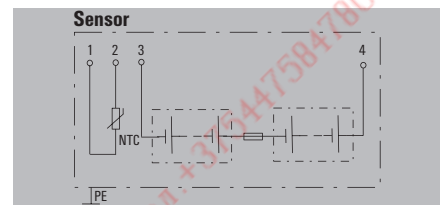

24 V DC
17 Ah
2.55 A
2x25 A fuse
81 min
34.2 min
50 A
Yes
No
NTC 100 kΩ
Maintenance-free AGM lead-acid battery
6...9 years @ 20°C
0°...+40°C (Charging); -15°...+50°C (Discharging)
-15 °C...40 °C
9 months
5 %...95 % RH
III, with no ground connection, for SELV
IP20
- / 0.7 g
30 g
/ 160 / 242 / 178 mm / 13330 Kg
cULus; EAC

Input/output/battery	Signal
	Pluggable screw connection
0.2 / 16	0.2 / 1.5
0.5 / 16	0.2 / 1.5
22 / 6	28 / 16
1.2...1.5	

Type	Qty.	Order No.
CP A BATTERY 24V DC17AH	1	1251110000

Buffer modules

Buffer modules

- Maintenance-free UPS on a capacitor basis, with a capacity of 20 A / 260 ms
- Parallel switching to increase the output current or buffer time
- Status notification via LED and relay contact

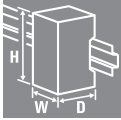

CP DC BUFFER 24V 20A

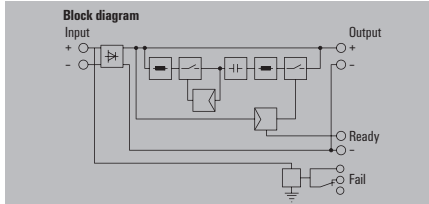

Technical data

Input
Rated input voltage
Input current
Max. approved input current
Surge protection
Output
Output voltage
Output current
Output current, max.
Parallel connection option
Overload protection
Surge protection
Status relay (max. load)
Display
Status indicator
General data
Degree of efficiency
Insulation voltage, input/output
Storage medium
Buffer times
MTBF
Ambient temperature (operational)
Storage temperature
Humidity
Depth x width x height / Net weight
For use with electronic equipment
Approvals

24 V DC
0...22 A
22 A
31 ... 34 V (only at discharge)
24 V
20 A
22 A
Yes, without diode module
≥ 22 A (only at discharge)
31 ... 34 V (only at discharge)
Input voltage OK (30 V AC/DC 2A), Ready for operation (24 V AC/DC 300 mA)
Green LED
95 %
1 kV
Internal condenser
250 ms at 20 A, 6 s at 1 A
> 500,000 h acc. to IEC 1709 (SN29500)
-25 °C...70 °C
-40 °C...85 °C
5...95 %, no condensation
/ 150 / 66 / 130 mm / 1280 g
Acc. to EN50178 / VDE0160
cURus; EAC

Connection data
Connection system
Number of terminals
Wire cross-section, rigid min/max
Wire cross-section, flexible min/max
Wire cross-section, AWG/kcmil min/max
Tightening torque range
Note

Input	Output
Screw connection	
0.5 / 16	

Ordering data

Note

Type	Qty.	Order No.
CP DC BUFFER 24V 20A	1	1251220000

Small metal foot



Type	Order No.
MTA 30 MF	1251320000

Large metal foot



Type	Order No.
MTA 45 MF	1251310000

Small plastic foot



Type	Order No.
MTA 30 BK	1168970000

Large plastic foot



Type	Order No.
MTA 45 BK	1962250000

Small wall mounting



Type	Order No.
CP A WALLADAPTER 30 MM	1461870000

Large wall mounting



Type	Order No.
CP A WALLADAPTER 45 MM	1461850000

Temperature probe



Type	Cable length	Order No.
CP DC UPS TF25	2.5 m	1444540000
CP DC UPS TF05	0.5 m	1444480000

Small screwdriver

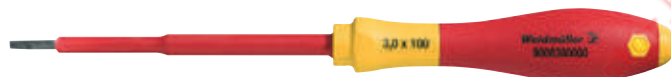

Type	Blade type	Size/AF	a	b	c	Order No.
SDIS 0.5X3.0X100	B		0.5	3	100	9008380000

Large screwdriver

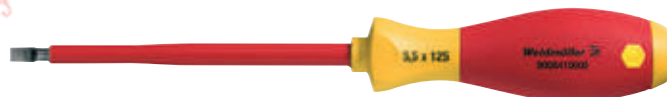

Type	Blade type	Size/AF	a	b	c	Order No.
SDIS 1.0X5.5X125	B		1	5.5	125	9008410000

Markers



Type	Colour	Qty.	Order No.
SM 18/9.5 K MC NE WS	white	200	1248580000

End bracket

For DIN rail TS 35



Type	Colour	Torque	Qty.	Order No.
Polyamide with fibre glass, screwable WEW 35/1 SW	black	1.2 Nm	50	1162600000

г. Минск www.fotorele.net www.tiristor.by email minsk17@tut.by тел. +375447584780

Load monitoring for 24 V DC circuits

Load monitoring for 24 V DC circuits	Overview	C.2
	maxGUARD	C.8

г. Минск www.fotorele.net www.tiristor.by email minsk17@tut.by тел. +375447584780

Load monitoring and potential distribution in one complete solution maxGUARD – taking control voltage distribution to a new level

C

Fail-safe and maintenance-friendly control voltage distributions that can be installed in a time- and space-saving manner are a must for efficient machine and facility operation. With the new maxGUARD system, the terminal blocks (previously installed separately) for distributing potential to the outputs of the electronic load monitors become an integral part of a 24 V DC control voltage distribution solution. The new combination of load monitoring and potential distribution saves time during installation, increases safety against failure and reduces the amount of space required on the terminal rail by 50 %.



Extreme ease of servicing

Sophisticated operating, testing and connection elements permit safe access to all voltage potentials and load circuits during commissioning and maintenance.

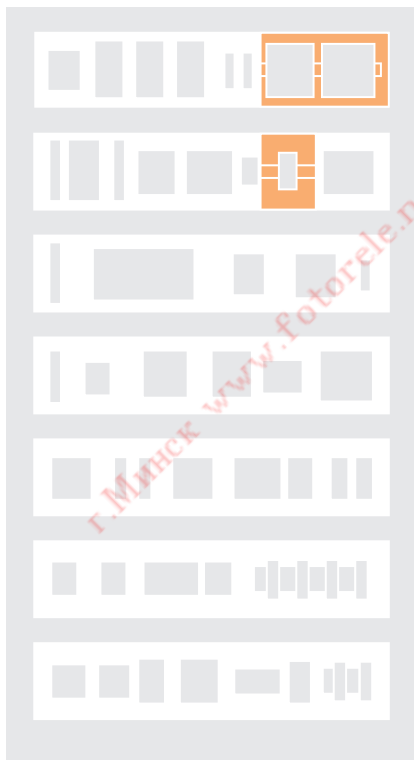
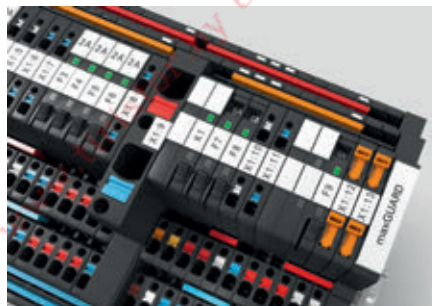

Particularly space-saving

Electronic load monitors and potential distributors with a 6.1 mm pitch.



Integrated test point

Consistently integrated test points in the maxGUARD control voltage distribution's input and output speed up troubleshooting operations.

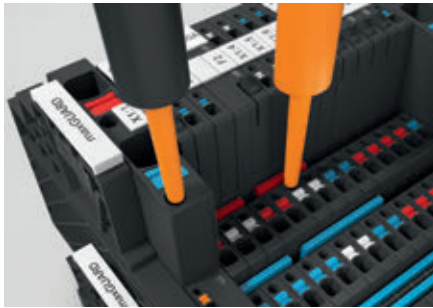

Practical disconnecting lever

Potential distributor with a disconnecting lever for simple galvanic isolation of the load circuit for testing and checking purposes.



Unique cross-connectors

Less time and effort needed for wiring due to cross-connections between load monitoring and potential distribution terminals.



Can be used in a customised way

The sheer range of variants and the very different potential distribution terminals and additional components enable customised solutions at all times.

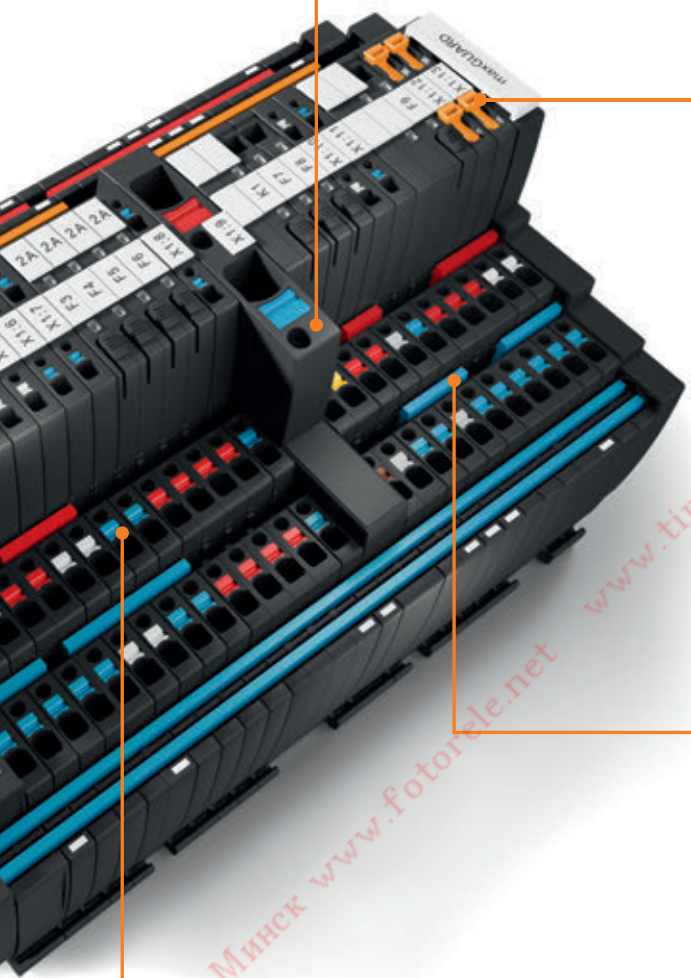

www.fotorele.net www.tiristor.by email m... +375447584780

maxGUARD – the concept

Time- and space-saving control voltage distribution

C

Combination of load monitoring and potential distribution

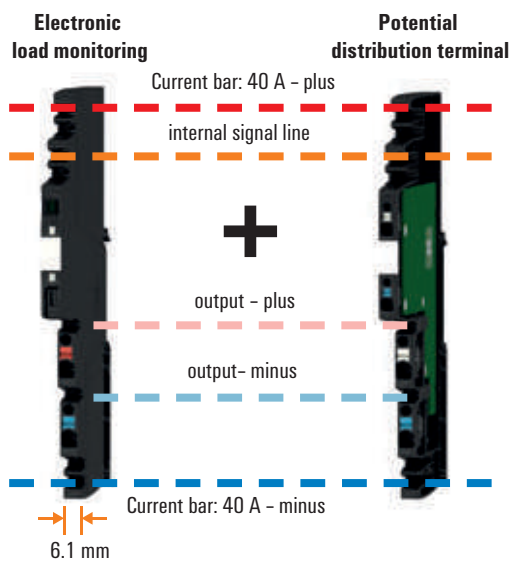

- Three main connection channels: positive, negative and internal signals
- Simple to increase the number of contacts thanks to crossconnection option in the potential distribution terminals

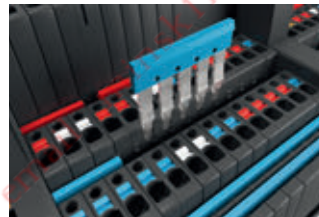

Sophisticated arrangement of connections and markers ensures clarity

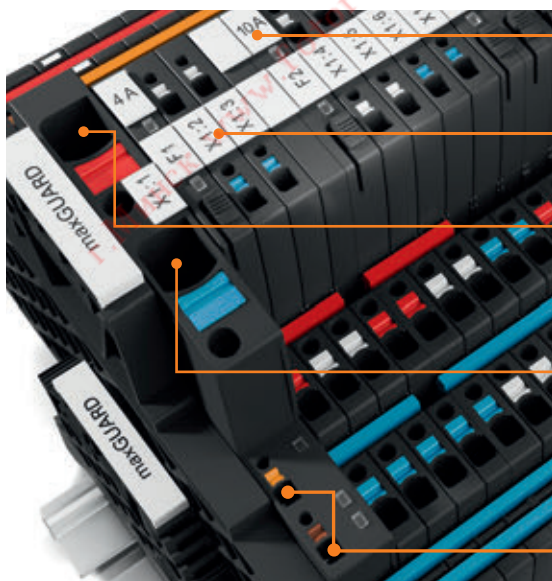

Markers for current strength

Continuous marker channel for equipment ID

Supply terminal (positive): 16 mm²

Supply terminal (negative): 16 mm²

Reset input and alarm output for connecting to the PLC

Signaling LEDs enable immediate status indication and monitoring

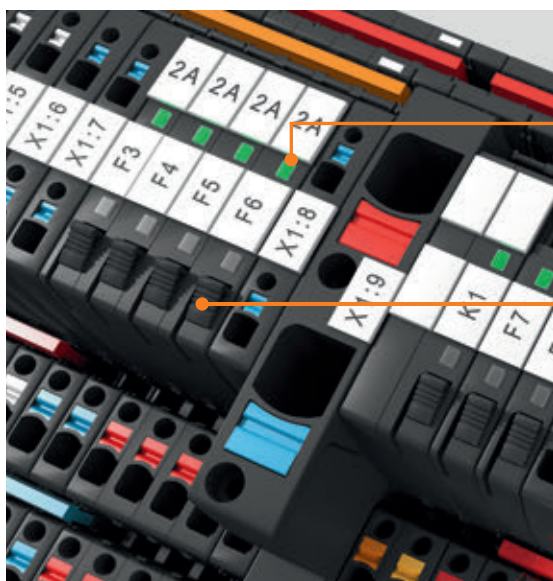

Green/red LED status indicator

LED Status	Meaning
LED green	Load monitoring is switched on
LED green flashing	Overcurrent advance warning (>90 %)
LED red	Load monitoring is switched off
LED red flashing	Load monitoring has been initiated
LED red fast flashing	Internal error

Load monitoring status	Pressing the button
LED green, in operation	>0.1 to 2 s (manual switch-off)
LED red flashing, Load monitoring has been initiated (switched off)	>0.1 to 2 s (confirm and reset)
LED red (permanently lit)	>0.1 to 2 s (restart)

Multicoloured pushers simplify the identification of active and passive components when connecting cross bridges

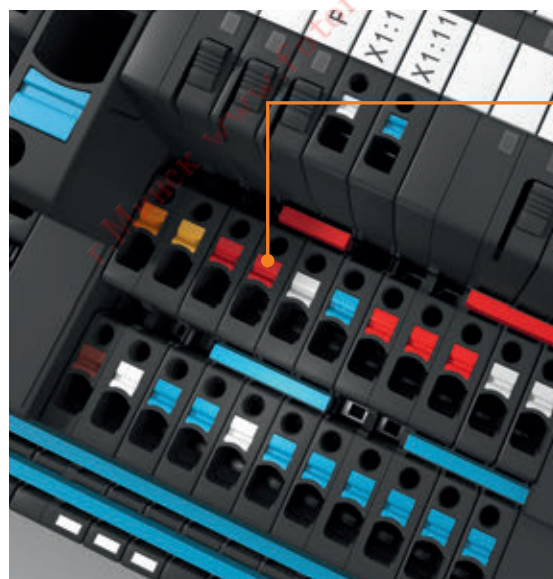

Pushers

Red pushers indicate the active output terminals of the electronic load monitoring elements. Blue or white pushers indicate the output terminals of the potential distributors.

High level of modularity for optimal adaptability

Customised solutions made simple with maxGUARD

C

maxGUARD is breaking new ground in control voltage distribution. The combination of load monitoring elements and potential distribution terminals saves up to 50 % space and up to 20 % time with wiring work, while the flexible compatibility of numerous single-channel and four-channel variations optimises material costs. maxGUARD offers you the benefits of a modular, highly flexible system that can be optimally adapted to any application.

1.

A maxGUARD station should always begin with an end bracket WEW 35/2, an end plate AMG EP and a supply terminal, and should always end with an end plate and an end bracket.

2.

For system currents >20 A, a the main connection channels must be configured in duplicate.

3.

The use of control modules allows for the segmentation of a maxGUARD station.

4.

The markings on the plastic tabs denote the active inserted cross-connection sockets, whereby the upper and lower contact for each are electrically connected to one other. These sockets can be used to extend the cross bridges for currents of up to 20 A (see point 7).

Segment (see point 3)

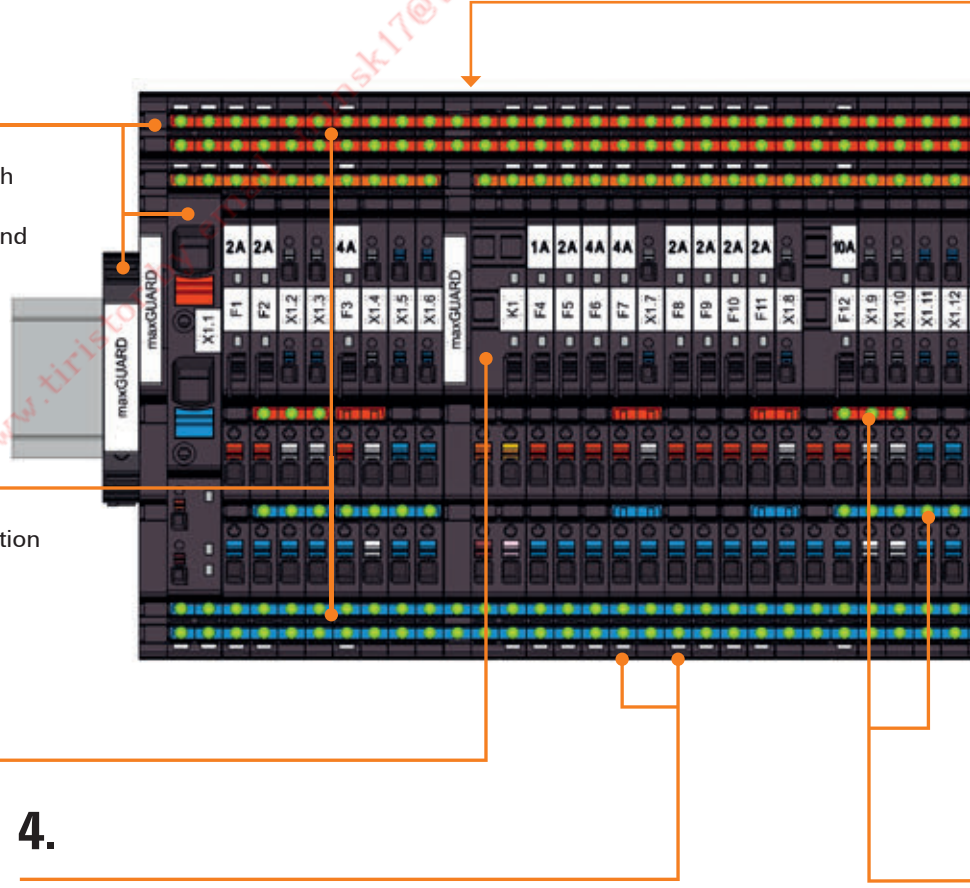

The maxGUARD wizard enables the simple and fast configuration of the optimal station for your application. We are happy to provide you with data for further planning.

www.weidmueller.com/configurator

8.

An alarm module can be connected as desired and offers potential-free decoupling of the "Alarm" and " $I > 90\%$ " signals.

7.

The main channels for positive and negative and the internal signal line are designed as double-shaft channels.

This allows smaller systems with currents of up to 20 A to be easily expanded at any time. There are different ways to achieve system currents >20 A:

- By using longer cross-connection bridges
- By installing a passive supply terminal directly behind the last cross-connection PIN and shifting the main cross bridges over to the next PIN on the right, so that the first and last supply terminals are connected to the cross-connector.

6.

Non-insulated cross-connectors must be used for cross bridges with >10 poles in the load monitoring outputs, multi-pole. In order to avoid short circuits with adjacent cross-connectors, a separation plate must be installed.

5.

The cross-bridging of load monitoring outputs in the potential distribution terminals must always be performed with insulated prefabricated bridges. This prevents the risk of short circuits occurring if there are cross bridges directly adjacent from an adjoining load monitoring circuit. Insulated prefabricated bridges are available with 2 to 10 poles.

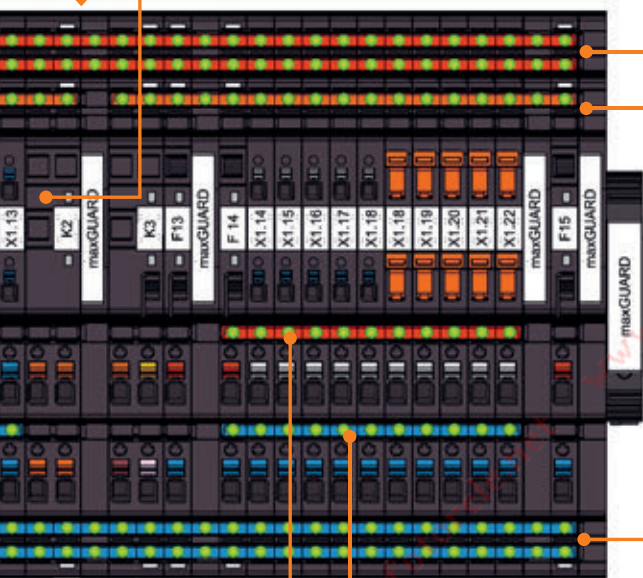





maxGUARD – product overview

Flexible and modular design

C



Supply terminals, control and alarm modules



			
Supply terminal 16 mm ² Passive	Supply terminal 16 mm ² With alarm and reset function	Control module Alarm Reset >90 % ON/OFF	Alarm module Potential-free contacts for alarm >90 %

Electronic load monitoring



		
Fixed-value modules 1 / 2 / 4 / 6 A 6.1 mm housing 8 A / 10 A 12.2 mm housing	Adjustable modules 1 - 2 - 3 - 4 - 6 A 6.1 mm housing 4 - 6 - 8 - 10 - 12 A 12.2 mm housing	Load monitoring (4-channel) 2-2-2-2 A, 4-4-4-4 A 6-6-6-6 A, 2-2-4-4 A 2-2-6-6 A Monitored individually Negative potential thanks to use of AMG XMD potential distribution terminals 24.4 mm housing

Power-feed, control and alarm module

Alarm module with potential-free contacts for the "Alarm" and ">90%" signals. Control module with extended control function. Passive or active power-feed module with reset and alarm function

Load monitoring (fixed value)

Electronic load monitoring with fixed current (without I >90% function)

Load monitoring adjustable

Electronic load monitoring with adjustable triggering current and triggering characteristic (with I >90% function)

Load monitoring, 4 channels

4-channel electronic load monitoring with fixed triggering current (without I >90% function)

Type	Order No.
AMG FIM-O	2081870000
AMG FIM-C	2081880000
AMG FIM-O EX	2082530000
AMG FIM-C EX	2082540000
AMG CM	2081900000
AMG CM EX	2083360000
AMG AM	2081890000
AMG AM CO	2082770000

Type	Order No.
AMG ELM-1F	2080420000
AMG ELM-1F EX	2082040000
AMG ELM-2F	2080480000
AMG ELM-2F EX	2082050000
AMG ELM-4F	2080490000
AMG ELM-4F EX	2082060000
AMG ELM-6F	2080500000
AMG ELM-6F EX	2082310000
AMG ELM-8F	2080600000
AMG ELM-8F EX	2082320000
AMG ELM-10F	2080650000
AMG ELM-10F EX	2082430000

Type	Order No.
AMG ELM-6	2080360000
AMG ELM-6 EX	2082000000
AMG ELM-12	2080410000
AMG ELM-12 EX	2082010000

Type	Order No.
AMG ELM-Q2222	2080750000
AMG ELM-Q2244	2081650000
AMG ELM-Q2266	2081820000
AMG ELM-Q4444	2080880000
AMG ELM-Q6666	2080920000

Potential distribution and accessories

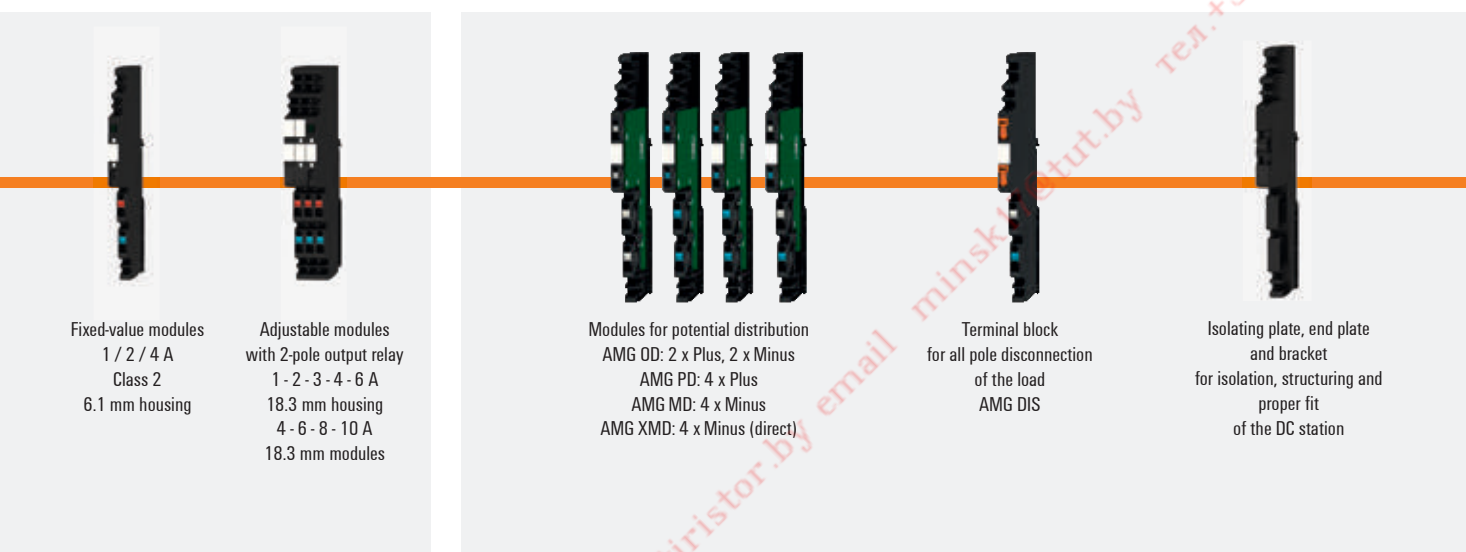

Fixed-value modules
1 / 2 / 4 A
Class 2
6.1 mm housing

Adjustable modules
with 2-pole output relay
1 - 2 - 3 - 4 - 6 A
18.3 mm housing
4 - 6 - 8 - 10 A
18.3 mm modules

Modules for potential distribution
AMG OD: 2 x Plus, 2 x Minus
AMG PD: 4 x Plus
AMG MD: 4 x Minus
AMG XMD: 4 x Minus (direct)

Terminal block
for all pole disconnection
of the load
AMG DIS

Isolating plate, end plate
and bracket
for isolation, structuring and
proper fit
of the DC station

Load monitoring (fixed value)
Class 2

Electronic load monitoring with fixed rated current (without I > 90 % pre warning) Class 2 Approval

Load monitoring with relay

Electronic load monitoring with 2-pole output relay for allpole load disconnection; triggering current and triggering characteristic adjustable (with I > 90% function)

Potential distributor

Flexible application through various potential distributor.

End plate and Separation plate

End plate for mechanical stabilization. Separation plate for logical subdivision.

Type	Order No.
AMG ELM-1F CL2	2491270000
AMG ELM-2F CL2	2491280000
AMG ELM-4F CL2	2491290000

Type	Order No.
AMG ELM-6D CO	2082440000
AMG ELM-10D CO	2082470000

Type	Order No.
AMG MD	2122930000
AMG MD EX	2495040000
AMG OD	2122910000
AMG OD EX	2495090000
AMG PD	2122920000
AMG PD EX	2495070000
AMG XMD	2122940000
AMG XMD EX	2495080000
AMG DIS	2123050000
AMG DIS EX	2495100000

Type	Order No.
AMG PP	2123000000
AMG EP	2495380000
AMG EP KIT	2500760000

maxGUARD

maxGUARD – power-feed module

Passive power-feed module

AMG FIM-0

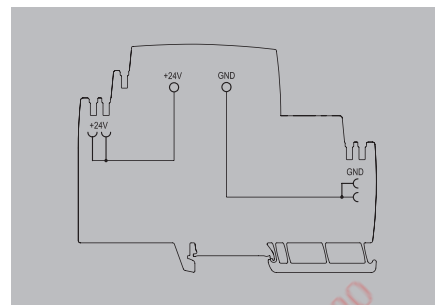

Technical data

Input			
Input fuse (internal)	No		
DC input voltage range	18...30 V DC		
Rated input voltage	24 V DC		
Current consumption (idle)			
Current consumption (full load)			
max. admissible residual ripple at the input	100 mVpp		
Surge protection			
General data			
Protection degree	IP20		
Control inputs	No		
Overvoltage category	III		
Connection data			
Number of terminals	2 (+,-)		
Wire cross-section, AWG/kcmil min/max	18..6		
Wire cross-section, flexible min/max	0.75...16 mm ²		
Wire cross-section, rigid min/max	0.75...10 mm ²		
Screwdriver blade	1.2 x 6.5		
Approvals			
Approvals	CE (in preparation: TÜV (60950), cULus, UL 2367)		
Note			
Ordering data			
Rated current	Type	Qty.	Order No.
	AMG FIM-0	1	2081870000
Note			

г. Минск www.fotorele.net www.kiribator.by email: minsk17@tut.by тел. +375447584700

maxGUARD – power-feed module

Active power-feed module with reset and alarm function

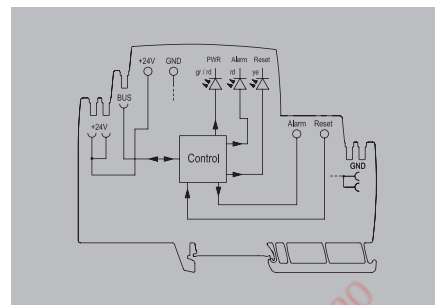
AMG FIM-C**Technical data**

Input
Input fuse (internal)
DC input voltage range
Rated input voltage
Current consumption (idle)
Current consumption (full load)
max. admissible residual ripple at the input
Surge protection
General data
Protection degree
Control inputs
Overvoltage category
Signalling
LED yellow
LED green
LED red
Transistor output, positive-switching
Connection data
Number of terminals
Wire cross-section, AWG/kcmil min/max
Wire cross-section, flexible min/max
Wire cross-section, rigid min/max
Screwdriver blade
Approvals
Approvals
Note

No
18...30 V DC
24 V DC
20 mA
120 mA
100 mVpp
Suppressor diode
IP20
Reset
III
External reset is signalled, Alarm is signalled
Operating voltage OK
Alarm
Alarm
2 (+,-)
18...6
0.75...16 mm ²
0.75...10 mm ²
1.2 x 6.5
CE (in preparation: TÜV (60950), cULus, UL 2367)

Ordering data

Rated current
Note

Type	Qty.	Order No.
AMG FIM-C	1	2081880000

maxGUARD

maxGUARD – load monitoring (fixed value)

Electronic load monitoring with fixed current (without I > 90% function)

Technical data

Input

Input fuse (internal)
 DC input voltage range
 Rated input voltage
 Current consumption (idle) / Current consumption (full load)
 max. admissible residual ripple at the input

Output

Connection system
 Triggering characteristic
 Switch-on delay
 Capacitive load

Surge protection

Function key

LED initial state

Pressing the button

LED, subsequent state
 Output, subsequent state

General data

Relay to activate the output
 Protection degree / Overvoltage category

Signalling

LED green
 LED red

Connection data

Number of terminals
 Wire cross-section, AWG/kcmil min/max
 Wire cross-section, flexible min/max
 Wire cross-section, rigid min/max
 Screwdriver blade

Approvals

Approvals

Note

Ordering data

Rated current	
1.00 A	
2.00 A	
4.00 A	
6.00 A	

Note

Accessories

Note

AMG ELM - xF

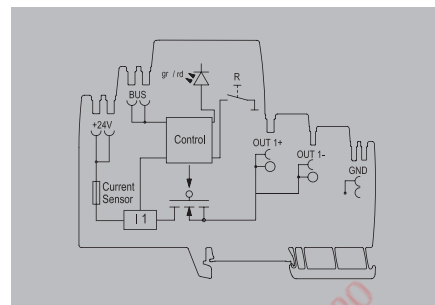

Input

Yes
 18...30 V DC
 24 V DC
 25 mA / I_{load} +30 mA
 100 mVpp

Output

PUSH IN
 see characteristic curve
 1 s
 2080420000: 10,000 µF;
 2080480000: 10,000 µF;
 2080490000: 10,000 µF;
 2080500000: 15,000 µF

Suppressor diode

LED green, in operation	LED flashing red, load monitoring has triggered (disconnected)	LED red (permanently lit)
> 0.1 to 2 s (manual disconnect)	> 0.1 to 2 s (confirm and reset)	> 0.1 to 2 s (restart)

Red LED switched off	Red LED switched off	LED green switched on
No	No	No

Operation (failure-free)

Load monitoring has disconnected, Load monitoring has triggered (flashing), Internal error (rapid flashing)

2 (+ / -)

26...12
0.14...2.5 mm ²
0.14...2.5 mm ²
0.6 x 3.5

CE (in preparation: TÜV (60950), cULus, UL 2367)

Type	Qty.	Order No.
AMG ELM-1F	1	2080420000
AMG ELM-2F	1	2080480000
AMG ELM-4F	1	2080490000
AMG ELM-6F	1	2080500000

Type	Qty.	Order No.
AMG DIS	10	2123050000
AMG MD	10	2122930000
AMG OD	10	2122910000
AMG PD	10	2122920000

Tripping characteristic normal – AMG ELM-1F

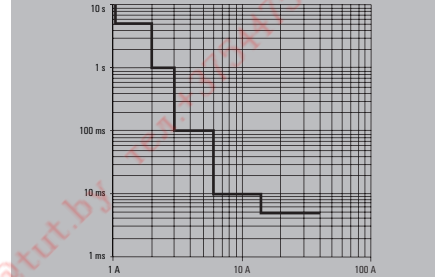

Tripping characteristic normal – AMG ELM-2F

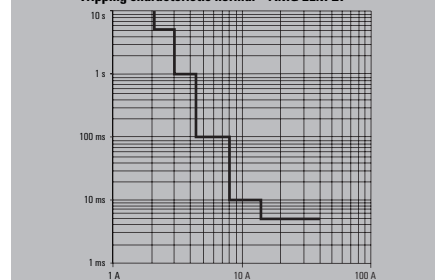

Tripping characteristic normal – AMG ELM-4F

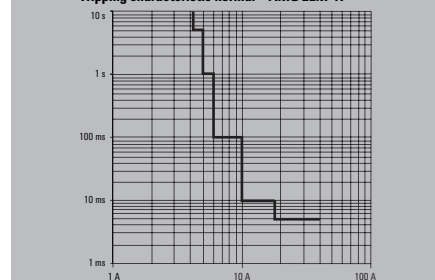

Tripping characteristic normal – AMG ELM-6F

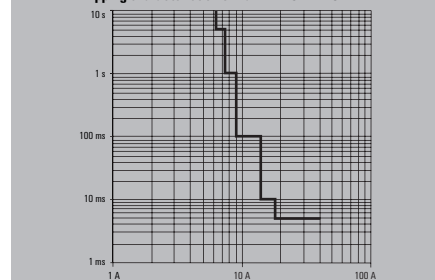

maxGUARD – load monitoring (fixed value)

Electronic load monitoring with fixed rated current (without I > 90 % pre warning)

AMG ELM - xF

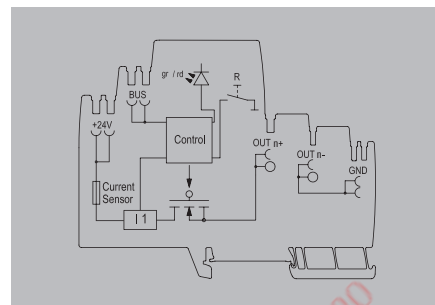

Technical data

Input	
Input fuse (internal)	Yes
DC input voltage range	18...30 V DC
Rated input voltage	24 V DC
Current consumption (idle)	25 mA
Current consumption (full load)	I _{OUT} +30 mA
max. admissible residual ripple at the input	100 mVpp
Surge protection	Suppressor diode
Output	
Connection system	PUSH IN
Triggering characteristic	see characteristic curve
Switch-on delay	1 s
Capacitive load	2080600000: 15,000 µF; 2080650000: 20,000 µF
Function key	
LED initial state	LED green, in operation
Pressing the button	> 0.1 to 2 s (manual disconnect)
LED, subsequent state	LED flashing red, load monitoring has triggered (disconnected)
Output, subsequent state	Red LED switched off
General data	
Relay to activate the output	No
Protection degree	IP20
Oversvoltage category	III
Signalling	
LED green	Operation (failure-free)
LED red	Load monitoring has disconnected, Load monitoring has triggered (flashing), Internal error (rapid flashing)
Connection data	
Number of terminals	4 (++ / -)
Wire cross-section, AWG/kcmil min/max	26...12
Wire cross-section, flexible min/max	0.14...2.5 mm ²
Wire cross-section, rigid min/max	0.14...2.5 mm ²
Screwdriver blade	0.6 x 3.5
Approvals	
Approvals	CE (in preparation: TÜV (60950), cULus, UL 2367)
Note	

LED green, in operation	LED flashing red, load monitoring has triggered (disconnected)	LED red (permanently lit)
> 0.1 to 2 s (manual disconnect)	> 0.1 to 2 s (confirm and reset)	> 0.1 to 2 s (restart)
Red LED switched off	Red LED switched off	LED green switched on
Operation (failure-free)		
Load monitoring has disconnected, Load monitoring has triggered (flashing), Internal error (rapid flashing)		
Connection data		
4 (++ / -)		
26...12		
0.14...2.5 mm ²		
0.14...2.5 mm ²		
0.6 x 3.5		
Approvals		
CE (in preparation: TÜV (60950), cULus, UL 2367)		

Ordering data

Rated current	
	8.00 A
	10.00 A
Note	

Type	Qty.	Order No.
AMG ELM-8F	1	2080600000
AMG ELM-10F	1	2080650000

Accessories

Note	
------	--

Type	Qty.	Order No.
AMG DIS	10	2123050000
AMG MD	10	2122930000
AMG OD	10	2122910000
AMG PD	10	2122920000

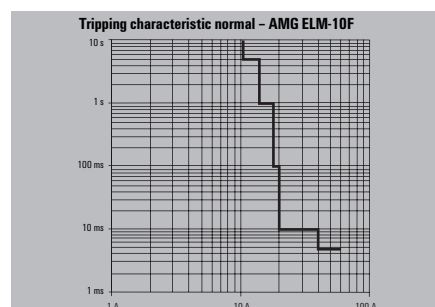
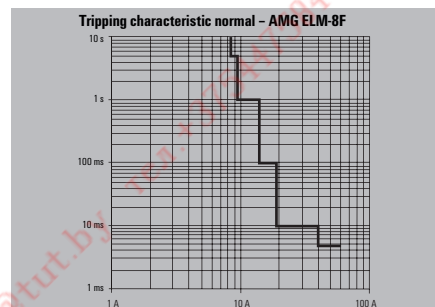

maxGUARD

**maxGUARD – load monitoring (fixed value),
Class 2**

Electronic load monitoring with fixed rated current
(without I > 90 % pre warning)
• Class 2 Approval

AMG ELM - xF CL2

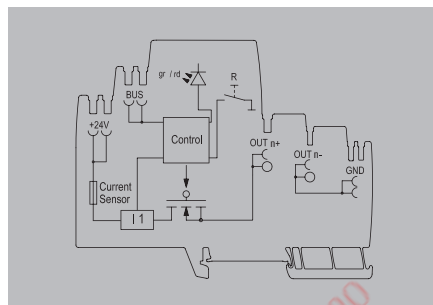

Technical data

Input	
Input fuse (internal)	Yes
DC input voltage range	18...30 V DC
Rated input voltage	24 V DC
Current consumption (idle)	25 mA
Current consumption (full load)	I _{OUT} +30 mA
max. admissible residual ripple at the input	100 mVpp
Surge protection	Suppressor diode
Output	
Connection system	PUSH IN
Triggering characteristic	see characteristic curve
Switch-on delay	1 s
Capacitive load	4.700 µF

Function key	
LED initial state	LED green, in operation

Pressing the button	> 0.1 to 2 s (manual disconnect)
---------------------	----------------------------------

LED, subsequent state	Red LED switched off
Output, subsequent state	LED green switched on

General data	
Relay to activate the output	No
Protection degree	IP20
Overvoltage category	III

Signalling	
LED green	Operation (failure-free)
LED red	Load monitoring has disconnected, Load monitoring has triggered (flashing), Internal error (rapid flashing)

Connection data	
Number of terminals	2 (+ / -)
Wire cross-section, AWG/kcmil min/max	26...12
Wire cross-section, flexible min/max	0.14...2.5 mm ²
Wire cross-section, rigid min/max	0.14...2.5 mm ²
Screwdriver blade	0.6 x 3.5

Approvals	
Approvals	CE (in preparation: TÜV (60950), cULus, UL 2367, class 2 (UL 1310))

Note	
------	--

Ordering data

	1.00 A
	2.00 A
	4.00 A
Note	

	LED flashing red, load monitoring has triggered (disconnected)	LED red (permanently lit)
	> 0.1 to 2 s (confirm and reset)	> 0.1 to 2 s (restart)
	Red LED switched off	LED green switched on

Operation (failure-free)	
	Load monitoring has disconnected, Load monitoring has triggered (flashing), Internal error (rapid flashing)

	2 (+ / -)
	26...12
	0.14...2.5 mm ²
	0.14...2.5 mm ²
	0.6 x 3.5

	CE (in preparation: TÜV (60950), cULus, UL 2367, class 2 (UL 1310))
--	---

Note	
------	--

Note	
------	--

Note	
------	--

Note	
------	--

Note	
------	--

Type	Qty.	Order No.
AMG ELM-1F CL2	1	2491270000
AMG ELM-2F CL2	1	2491280000
AMG ELM-4F CL2	1	2491290000

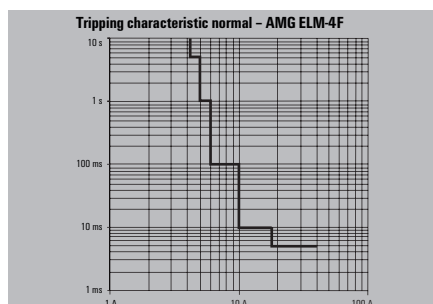
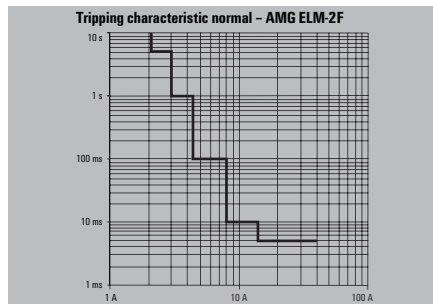
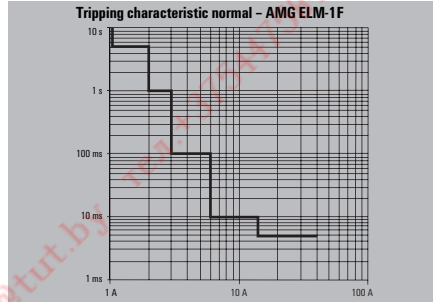

maxGUARD – load monitoring adjustable

Electronic load monitoring with adjustable triggering current and triggering characteristic

AMG ELM-6

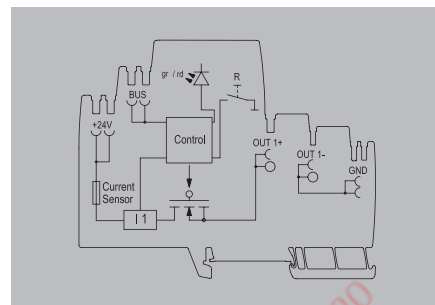

Technical data

Input	
Input fuse (internal)	Yes
DC input voltage range	18...30 V DC
Rated input voltage	24 V DC
Current consumption (idle)	25 mA
Current consumption (full load)	I _{OUT} +30 mA
max. admissible residual ripple at the input	100 mVpp
Output	
Connection system	PUSH IN
Triggering characteristic	see characteristic curve
Backup modes	1- 6 A
Switch-on delay	1 s
Capacitive load	15,000 µF
adjustable rated current	Yes
Surge protection	Suppressor diode
Function key	
LED initial state	LED green, in operation
Pressing the button	> 0.1 to 2 s (manual disconnect)
LED, subsequent state	LED flashing red, load monitoring has triggered (disconnected)
Output, subsequent state	> 0.1 to 2 s (confirm and reset)
LED, subsequent state	LED red (permanently lit)
LED, subsequent state	> 0.1 to 2 s (restart)
LED, subsequent state	Red LED switched off
LED, subsequent state	Red LED switched off
LED, subsequent state	LED green switched on
General data	
Relay to activate the output	No
Protection degree	IP20
Overvoltage category	III
Signalling	
LED green	Operation (failure-free), Early warning: I _{Out} > 90% I _{Rated} (flashing)
LED red	Load monitoring has disconnected, Load monitoring has triggered (flashing), Internal error (rapid flashing)
Connection data	
Number of terminals	2 (+ / -)
Wire cross-section, AWG/kcmil min/max	26...12
Wire cross-section, flexible min/max	0.14...2.5 mm ²
Wire cross-section, rigid min/max	0.14...2.5 mm ²
Screwdriver blade	0.6 x 3.5
Approvals	
Approvals	CE (in preparation: TÜV (60950), cULus, UL 2367)
Note	

Ordering data

Rated current	6.00 A
Note	

Accessories

Type	Qty.	Order No.
AMG DIS	10	2123050000
AMG MD	10	2122930000
AMG OD	10	2122910000
AMG PD	10	2122920000
Note		

Type	Qty.	Order No.
AMG ELM-6	1	2080360000

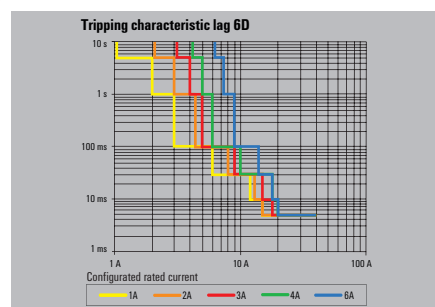
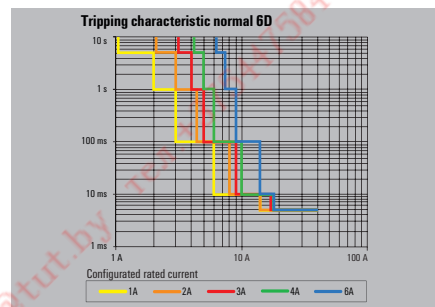

maxGUARD

maxGUARD – load monitoring adjustable

Electronic load monitoring with adjustable trigger current and characteristic (with I > 90 % pre warning)

AMG ELM-12

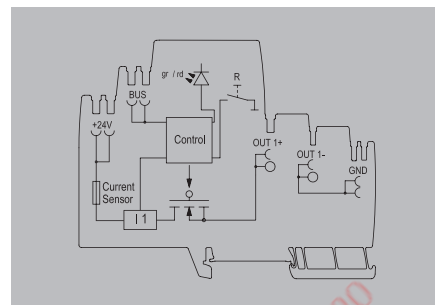

Technical data

Input	
Input fuse (internal)	Yes
DC input voltage range	18...30 V DC
Rated input voltage	24 V DC
Current consumption (idle)	25 mA
Current consumption (full load)	I _{OUT} +30 mA
max. admissible residual ripple at the input	100 mVpp
Output	
Connection system	PUSH IN
Triggering characteristic	see characteristic curve
Backup modes	4-12 A
Switch-on delay	1 s
adjustable rated current	Yes
Capacitive load	20,000 µF
Surge protection	Suppressor diode
Function key	
LED initial state	LED green, in operation
Pressing the button	> 0.1 to 2 s (manual disconnect)
LED, subsequent state	LED flashing red, load monitoring has triggered (disconnected)
Output, subsequent state	switched off
General data	
Relay to activate the output	No
Protection degree	IP20
Overvoltage category	III
Signalling	
LED green	Operation (failure-free), Early warning: I Out > 90% I Rated (flashing)
LED red	Load monitoring has disconnected, Load monitoring has triggered (flashing), Internal error (rapid flashing)
Connection data	
Number of terminals	4 (++) / -)
Wire cross-section, AWG/kcmil min/max	26...12
Wire cross-section, flexible min/max	0.14...2.5 mm ²
Wire cross-section, rigid min/max	0.14...2.5 mm ²
Screwdriver blade	0.6 x 3.5
Approvals	
Approvals	CE (in preparation: TÜV (60950), cULus, UL 2367)
Note	

Ordering data

Rated current	12.00 A
Note	

Accessories

Type	Qty.	Order No.
AMG DIS	10	2123050000
AMG MD	10	2122930000
AMG OD	10	2122910000
AMG PD	10	2122920000
Note		

Yes	LED green, in operation	LED flashing red, load monitoring has triggered (disconnected)	LED red (permanently lit)
> 0.1 to 2 s (manual disconnect)	> 0.1 to 2 s (confirm and reset)	> 0.1 to 2 s (restart)	
switched off	switched off	switched on	
No			
IP20			
III			
Operation (failure-free), Early warning: I Out > 90% I Rated (flashing)			
Load monitoring has disconnected, Load monitoring has triggered (flashing), Internal error (rapid flashing)			
4 (++) / -)			
26...12			
0.14...2.5 mm ²			
0.14...2.5 mm ²			
0.6 x 3.5			
CE (in preparation: TÜV (60950), cULus, UL 2367)			

Type	Qty.	Order No.
AMG ELM-12	1	2080410000

Type	Qty.	Order No.
AMG DIS	10	2123050000
AMG MD	10	2122930000
AMG OD	10	2122910000
AMG PD	10	2122920000

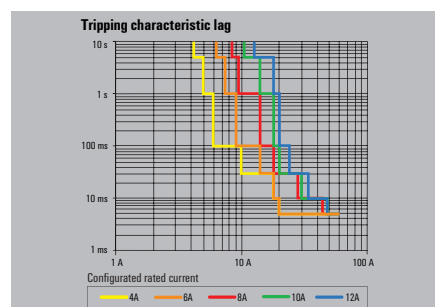
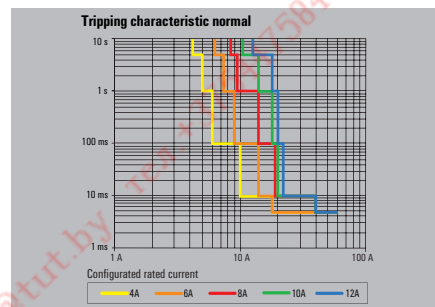

maxGUARD – load monitoring with relay

Electronic load monitoring with 2-pole output relay for all-pole load disconnection; triggering current and triggering characteristic adjustable.

Technical data

Input	
Input fuse (internal)	Yes
DC input voltage range	18...30 V DC
Rated input voltage	24 V DC
Current consumption (idle)	40 mA
max. admissible residual ripple at the input	100 mVpp

Output	
Connection system	PUSH IN
Triggering characteristic	see characteristic curve
Backup modes	2082470000: 4- 10 A 2082440000: 1- 6 A

Switch-on delay adjustable rated current
Capacitive load

Function key

LED initial state

Pressing the button

LED, subsequent state
Output, subsequent state

General data

Relay to activate the output
Protection degree / Surge protection
Conformal coating

Signalling

LED green
LED red

Connection data

Number of terminals
Wire cross-section, AWG/kcmil min/max
Wire cross-section, flexible min/max
Wire cross-section, rigid min/max
Screwdriver blade

Approvals

Approvals

Note

Ordering data

Rated current	
	6.00 A
	10.00 A

Note

Accessories

Note

AMG ELM – adjustable with output relay



Yes
18...30 V DC
24 V DC
40 mA
100 mVpp
PUSH IN
see characteristic curve
2082470000: 4- 10 A
2082440000: 1- 6 A

1 s
Yes
20,000 µF
15,000 µF
Suppressor diode

LED green, in operation	LED flashing red, load monitoring has triggered (disconnected)	LED red (permanently lit)
-------------------------	--	---------------------------

> 0.1 to 2 s (manual disconnect)	> 0.1 to 2 s (confirm and reset)	> 0.1 to 2 s (restart)
----------------------------------	----------------------------------	------------------------

Red LED switched off	Red LED switched off	LED green switched on
----------------------	----------------------	-----------------------

Yes
IP20 / Suppressor diode
Yes

Operation (failure-free), Early warning: I Out > 90% I Rated (flashing)
Load monitoring has disconnected, Load monitoring has triggered (flashing), Internal error (rapid flashing)

6 (3x + / 3x -)
26...12
0.14...2.5 mm ²
0.14...2.5 mm ²
0.6 x 3.5

CE (in preparation: TÜV (60950), cULus, UL 2367, GL-DNV, BV, ABS, LR, RINA, ISA 12.12.01, ATEX, IECEx)

Type	Qty.	Order No.
AMG ELM-6D CD	1	2082440000
AMG ELM-10D CD	1	2082470000

Type	Qty.	Order No.
AMG DIS	10	2123050000
AMG MD	10	2122930000
AMG OD	10	2122910000
AMG PD	10	2122920000

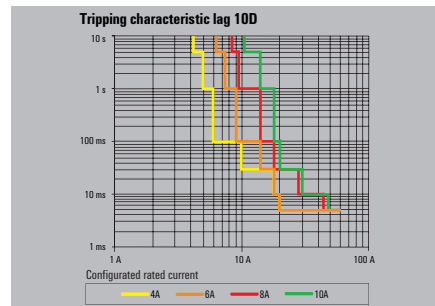
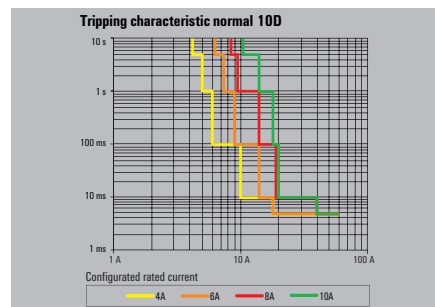
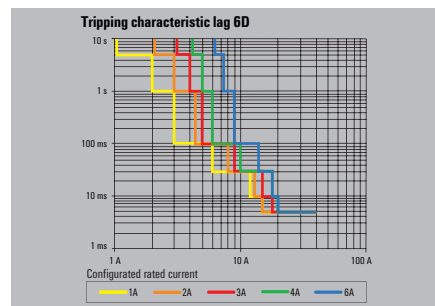
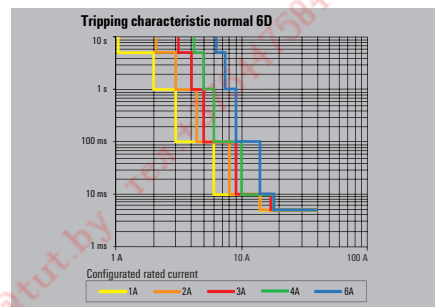
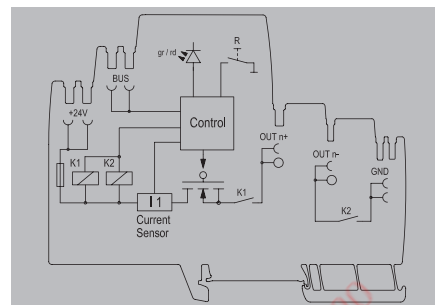

maxGUARD

maxGUARD – load monitoring, 4 channels

4-channel electronic load monitoring with fixed triggering current.

Technical data

Input	
Input fuse (internal)	Yes
DC input voltage range	18...30 V DC
Rated input voltage	24 V DC
Current consumption (idle) / Current consumption (full load)	35 mA / 4x I _{OUT} +45 mA
max. admissible residual ripple at the input	100 mVpp
Output	
Connection system	PUSH IN
Triggering characteristic	see characteristic curve
Switch-on delay	1 s
adjustable rated current	No
Capacitive load	10,000 µF
Surge protection	Suppressor diode
Rated current per channel	2080750000: 2 A; 2 A; 2 A; 2 A 2081650000: 2 A; 2 A; 4 A; 4 A 2081820000: 2 A; 2 A; 6 A; 6 A 2080880000: 4 A; 4 A; 4 A; 4 A 2080920000: 6 A; 6 A; 6 A; 6 A
Number of channels	4
Function key	
LED initial state	LED green, in operation LED flashing red, load monitoring has triggered (disconnected) LED red (permanently lit)
Pressing the button	> 0.1 to 2 s (manual disconnect) > 0.1 to 2 s (confirm and reset) > 0.1 to 2 s (restart)
LED, subsequent state	Red LED
Output, subsequent state	Red LED switched off Red LED switched off LED green switched on
General data	
Relay to activate the output	No
Protection degree / Overvoltage category	IP20 / III
Signalling	
LED green	Operation (failure-free)
LED red	Load monitoring has disconnected, Load monitoring has triggered (flashing), Internal error (rapid flashing)
Connection data	
Number of terminals	8 (4x ++)
Wire cross-section, AWG/kcmil min/max	26...12
Wire cross-section, flexible min/max	0.14...2.5 mm ²
Wire cross-section, rigid min/max	0.14...2.5 mm ²
Screwdriver blade	0.6 x 3.5
Approvals	
Approvals	CE (in preparation: TÜV (60950), cULus, UL 2367)
Note	

Ordering data

Rated current	
Note	

Accessories

Type	Qty.	Order No.
AMG XMD	10	2122940000
Note		

AMG ELM - Qxxxx

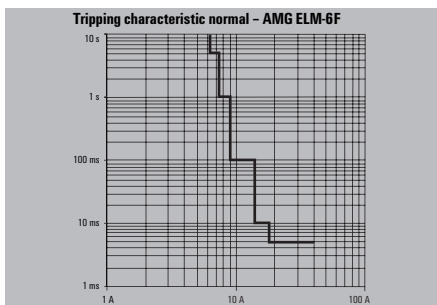
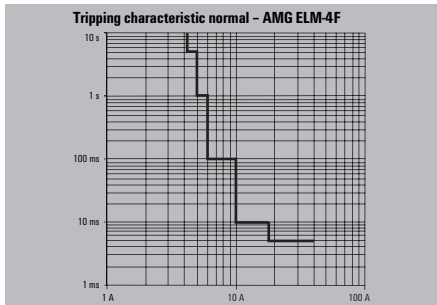
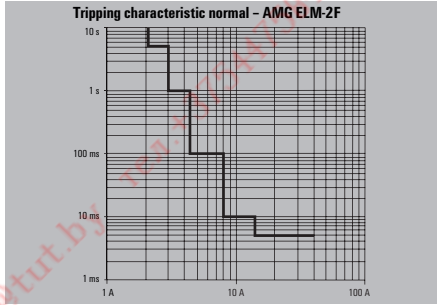
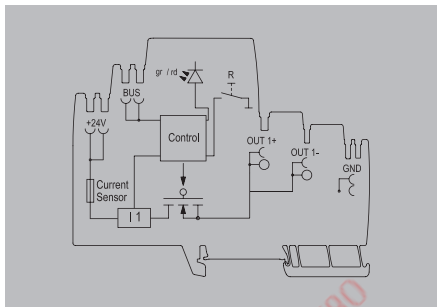

Type	Qty.	Order No.
AMG ELM-Q2222	1	2080750000
AMG ELM-Q2244	1	2081650000
AMG ELM-Q2266	1	2081820000
AMG ELM-Q4444	1	2080880000
AMG ELM-Q6666	1	2080920000

Type	Qty.	Order No.
AMG XMD	10	2122940000

maxGUARD – Alarm module

Alarm module with potential-free contacts for the "Alarm" and "I>90%" signals.

Technical data

Input
Input fuse (internal)
DC input voltage range
Rated input voltage
Current consumption (idle)
Current consumption (full load)
max. admissible residual ripple at the input
Surge protection
General data
Protection degree
Overvoltage category
Signalling
LED yellow
LED red
Floating contact
Status relay (max. load)
Connection data
Number of terminals
Wire cross-section, AWG/kcmil min/max
Wire cross-section, flexible min/max
Wire cross-section, rigid min/max
Screwdriver blade
Approvals
Approvals
Note

Ordering data

Rated current
Note

Accessories

Pluggable cross-connection
50-pole
50-pole / red
50-pole / blue
2-pole
2-pole / red
2-pole / blue
Note

AMG AM

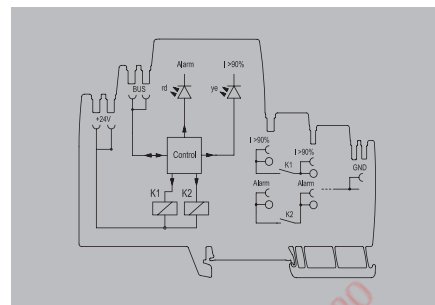

No
18...30 V DC
24 V DC
25 mA
30 mA
100 mVpp
Suppressor diode
General data
IP20
III
Signalling
Current > 90% Inom (flashing)
Alarm
Yes
Alarm (24 V / 0.1 A), I > 90% (24 V / 0.1 A)
Connection data
4 (2 x NO)
26...12
0.14...2.5 mm ²
0.14...2.5 mm ²
0.6 x 3.5
Approvals
CE (in preparation: TÜV (60950), cULus, UL 2367)
Note

Type	Qty.	Order No.
AMG AM	1	2081890000

Type	Qty.	Order No.
ZQV 4N/50	5	1528130000
ZQV 4N/50 RD	5	2460730000
ZQV 4N/50 BL	5	1528240000
ZQV 4N/2	60	1527930000
ZQV 4N/2 RD	60	2460450000
ZQV 4N/2 BL	60	1528040000

maxGUARD

maxGUARD – control module

Control module with extended control function: Alarm, Reset, I>90%, ON/OFF

AMG CM

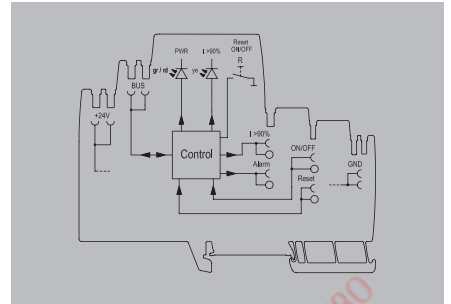

Technical data

Input	
DC input voltage range	18...30 V DC
Rated input voltage	24 V DC
Current consumption (idle)	25 mA
Current consumption (full load)	225 mA
max. admissible residual ripple at the input	100 mVpp
Output	
Connection system	PUSH IN
Surge protection	Suppressor diode
General data	
Relay to activate the output	No
Protection degree	IP20
Control inputs	ON/ OFF, Reset
Overvoltage category	III
Signalling	
LED green	Operation (failure-free), Early warning: I Out > 90% I Rated (flashing)
LED red	Load monitoring has disconnected, Load monitoring has triggered (flashing), Internal error (rapid flashing)
Transistor output, positive-switching	Pre-warning, Alarm
Connection data	
Number of terminals	2 (Reset / ON)
Wire cross-section, AWG/kcmil min/max	26...12
Wire cross-section, flexible min/max	0.14...2.5 mm ²
Wire cross-section, rigid min/max	0.14...2.5 mm ²
Screwdriver blade	0.6 x 3.5
Approvals	
Approvals	CE (in preparation: TÜV (60950), cULus, UL 2367)
Note	

Ordering data

Rated current	
Note	

Type	Qty.	Order No.
AMG CM	1	2081900000

Accessories

Pluggable cross-connection	
50-pole	ZQV 4N/50
50-pole / red	ZQV 4N/50 RD
50-pole / blue	ZQV 4N/50 BL
2-pole	ZQV 4N/2
2-pole/ red	ZQV 4N/2 RD
2-pole / blue	ZQV 4N/2 BL
Note	

Type	Qty.	Order No.
ZQV 4N/50	5	1528130000
ZQV 4N/50 RD	5	2460730000
ZQV 4N/50 BL	5	1528240000
ZQV 4N/2	60	1527930000
ZQV 4N/2 RD	60	2460450000
ZQV 4N/2 BL	60	1528040000

maxGUARD – Potential distributor

Potential distribution in combination with the electronic load monitoring.

AMG

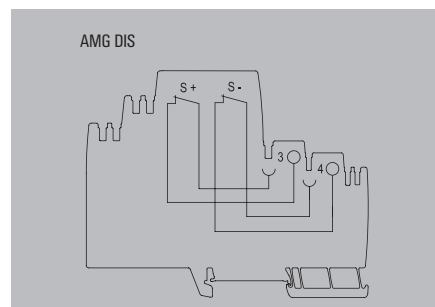
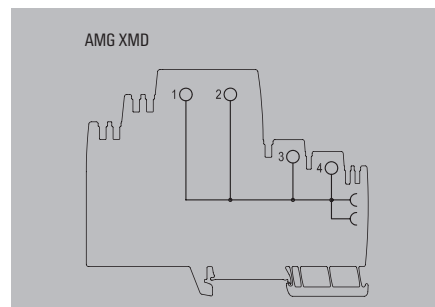
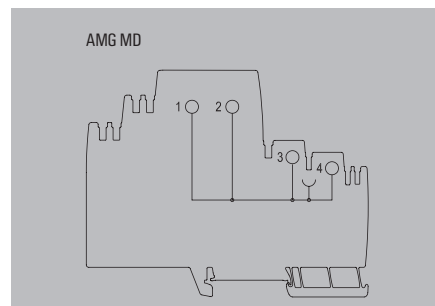
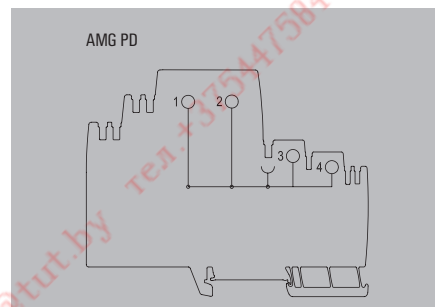
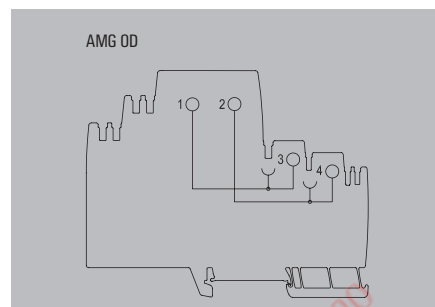
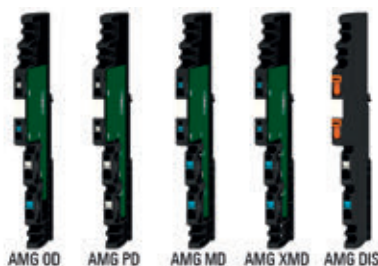

Technical data

General data
Protection degree
Total current load per potential
Current load per contact point
Connection data
Connection system
Number of terminals
Wire cross-section, AWG/kcmil min/max
Wire cross-section, flexible min/max
Wire cross-section, rigid min/max
Screwdriver blade
Approvals
Approvals
Note

IP20
2122910000: 12 A;
2122920000: 12 A;
2122930000: 12 A;
2122940000: 24 A;
2123050000: 12 A
12 A
PUSH IN
2 x 1.5 mm ² , 2 x 2.5 mm ²
26...12
0.14...2.5 mm ²
0.14...2.5 mm ²
0.6 x 3.5
CE (in preparation: TÜV (60950), cULus, UL 2367)

Ordering data

Note

Type	Qty.	Order No.
AMG OD	10	2122910000
AMG PD	10	2122920000
AMG MD	10	2122930000
AMG XMD	10	2122940000
AMG DIS	10	2123050000

Accessories

Pluggable cross-connection
50-pole
50-pole / red
50-pole / blue
2-pole
2-pole/ red
2-pole / blue
Note

Type	Qty.	Order No.
ZQV 4N/50	5	1528130000
ZQV 4N/50 RD	5	2460730000
ZQV 4N/50 BL	5	1528240000
ZQV 4N/2	60	1527930000
ZQV 4N/2 RD	60	2460450000
ZQV 4N/2 BL	60	1528040000

maxGUARD

maxGUARD – power-feed module

Passive power-feed module

AMG FIM-0 Ex

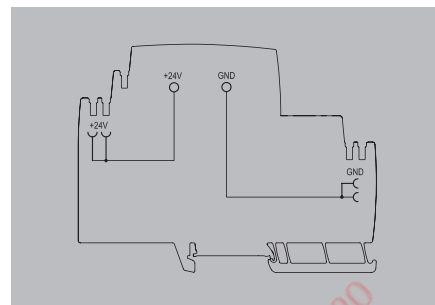

Technical data

Input	
Input fuse (internal)	No
DC input voltage range	18...30 V DC
Rated input voltage	24 V DC
Current consumption (idle)	
Current consumption (full load)	
max. admissible residual ripple at the input	100 mVpp
Surge protection	
General data	
Protection degree	IP20
Control inputs	No
Overvoltage category	III
Connection data	
Number of terminals	2 (+,-)
Wire cross-section, AWG/kcmil min/max	18..6
Wire cross-section, flexible min/max	0.75...16 mm ²
Wire cross-section, rigid min/max	0.75...10 mm ²
Screwdriver blade	1.2 x 6.5
Approvals	
Approvals	CE (in preparation: TÜV (60950), cULus, UL 2367, GL-DNV, BV, ABS, LR, RINA, ISA 12.12.01, ATEX, IECEx)
Note	
Ordering data	
Rated current	
Note	

Type	Qty.	Order No.
AMG FIM-0 EX	1	2082530000

г. Минск www.fotorele.net www.tut.by email: mmsk17@tut.by тел. +375447584700

maxGUARD – power-feed module

Active power-feed module with reset and alarm function

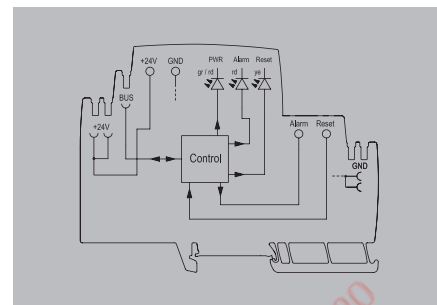
AMG FIM-C Ex**Technical data**

Input
Input fuse (internal)
DC input voltage range
Rated input voltage
Current consumption (idle)
Current consumption (full load)
max. admissible residual ripple at the input
Surge protection
General data
Protection degree
Control inputs
Oversvoltage category
Signalling
LED yellow
LED green
LED red
Transistor output, positive-switching
Connection data
Number of terminals
Wire cross-section, AWG/kcmil min/max
Wire cross-section, flexible min/max
Wire cross-section, rigid min/max
Screwdriver blade
Approvals
Approvals
Note
Ordering data
Rated current
Note

No		
18...30 V DC		
24 V DC		
20 mA		
120 mA		
100 mVpp		
Suppressor diode		
IP20		
Reset		
III		
External reset is signalled, Alarm is signalled		
Operating voltage OK		
Alarm		
Alarm		
2 (+,-)		
18...6		
0.75...16 mm ²		
0.75...10 mm ²		
1.2 x 6.5		
CE (in preparation: TÜV (60950), cULus, UL 2367, GL-DNV, BV, ABS, LR, RINA, ISA 12.12.01, ATEX, IECEx)		
Type	Qty.	Order No.
AMG FIM-C EX	1	2082540000

maxGUARD

maxGUARD – load monitoring (fixed value)

Electronic load monitoring with fixed current (without I > 90% function)

Technical data

Input
Input fuse (internal)
DC input voltage range
Rated input voltage
Current consumption (idle) / Current consumption (full load)
max. admissible residual ripple at the input
Output
Connection system
Triggering characteristic
Switch-on delay
Capacitive load
Surge protection
Function key
LED initial state
Pressing the button
LED, subsequent state
Output, subsequent state
General data
Relay to activate the output
Protection degree / Overvoltage category
Signalling
LED green
LED red
Connection data
Number of terminals
Wire cross-section, AWG/kcmil min/max
Wire cross-section, flexible min/max
Wire cross-section, rigid min/max
Screwdriver blade
Approvals
Approvals
Note

Ordering data

Rated current	1.00 A
	2.00 A
	4.00 A
	6.00 A
Note	

Accessories

Note

AMG ELM - xF Ex



Input	Yes
DC input voltage range	18...30 V DC
Rated input voltage	24 V DC
Current consumption (idle) / Current consumption (full load)	25 mA / I _{out} +30 mA
max. admissible residual ripple at the input	100 mVpp
Output	
Connection system	PUSH IN
Triggering characteristic	see characteristic curve
Switch-on delay	1 s
Capacitive load	2082040000: 10,000 µF; 2082050000: 10,000 µF; 2082060000: 10,000 µF; 2082310000: 15,000 µF
Surge protection	Suppressor diode
Function key	
LED initial state	LED green, in operation LED flashing red, load monitoring has triggered (disconnected) LED red (permanently lit)
Pressing the button	> 0.1 to 2 s (manual disconnect) > 0.1 to 2 s (confirm and reset) > 0.1 to 2 s (restart)
LED, subsequent state	Red LED switched off Red LED switched off LED green switched on
General data	
Relay to activate the output	No
Protection degree / Overvoltage category	IP20 / III
Signalling	
LED green	
LED red	
Connection data	
Number of terminals	2 (+ / -)
Wire cross-section, AWG/kcmil min/max	26...12
Wire cross-section, flexible min/max	0.14...2.5 mm ²
Wire cross-section, rigid min/max	0.14...2.5 mm ²
Screwdriver blade	0.6 x 3.5
Approvals	
Approvals	CE (in preparation: TÜV (60950), cULus, UL 2367, GL-DNV, BV, ABS, LR, RINA, ISA 12.12.01, ATEX, IECEx)
Note	

Type	Qty.	Order No.
AMG ELM-1F EX	1	2082040000
AMG ELM-2F EX	1	2082050000
AMG ELM-4F EX	1	2082060000
AMG ELM-6F EX	1	2082310000

Type	Qty.	Order No.
AMG DIS	10	2123050000
AMG MD	10	2122930000
AMG OD	10	2122910000
AMG PD	10	2122920000

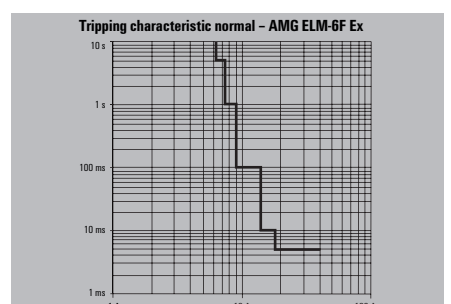
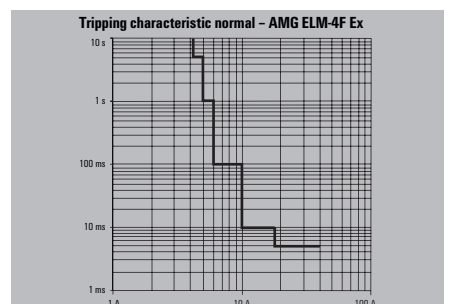
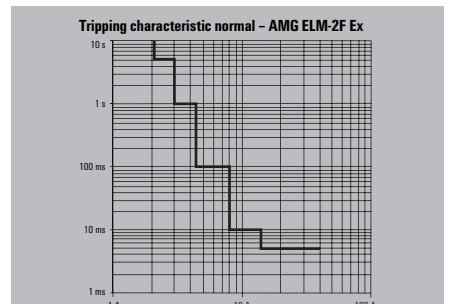
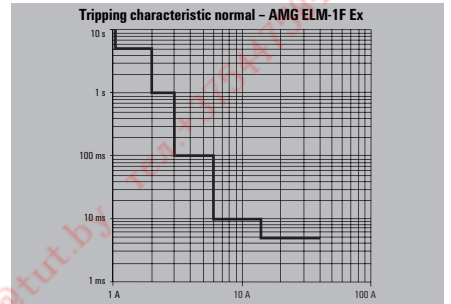
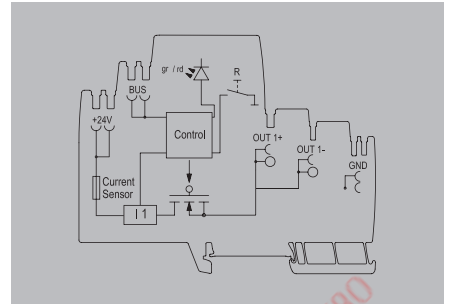

maxGUARD – load monitoring (fixed value)

Electronic load monitoring with fixed rated current (without I > 90 % pre warning)

AMG ELM - xF Ex

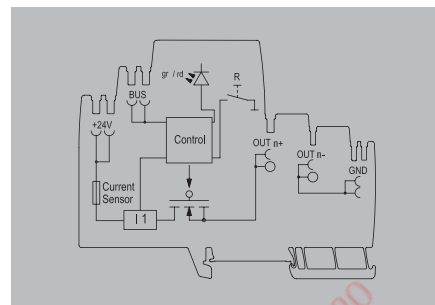

Technical data

Input

- Input fuse (internal)
- DC input voltage range
- Rated input voltage
- Current consumption (idle)
- Current consumption (full load)
- max. admissible residual ripple at the input
- Surge protection

Output

- Connection system
- Triggering characteristic
- Switch-on delay
- Capacitive load

Function key

LED initial state

Pressing the button

LED, subsequent state
Output, subsequent state

General data

- Relay to activate the output
- Protection degree
- Oversvoltage category

Signalling

- LED green
- LED red

Connection data

- Number of terminals
- Wire cross-section, AWG/kcmil min/max
- Wire cross-section, flexible min/max
- Wire cross-section, rigid min/max
- Screwdriver blade

Approvals

Approvals

Note

Ordering data

Rated current

- 8.00 A
- 10.00 A

Note

Accessories

Type

Note

Yes

- 18...30 V DC
- 24 V DC
- 25 mA
- I_{OUT} +30 mA
- 100 mVpp
- Suppressor diode
- PUSH IN
- see characteristic curve
- 1 s
- 2082320000: 15,000 µF;
- 2082430000: 20,000 µF

LED green, in operation	LED flashing red, load monitoring has triggered (disconnected)	LED red (permanently lit)
-------------------------	--	---------------------------

> 0.1 to 2 s (manual disconnect) > 0.1 to 2 s (confirm and reset) > 0.1 to 2 s (restart)

Red LED switched off	Red LED switched off	LED green switched on
----------------------	----------------------	-----------------------

No

IP20

III

Operation (failure-free)

Load monitoring has disconnected, Load monitoring has triggered (flashing), Internal error (rapid flashing)

4 (++ / -)

26...12

0.14...2.5 mm²

0.14...2.5 mm²

0.6 x 3.5

CE (in preparation: TÜV (60950), cULus, UL 2367, GL-DNV, BV, ABS, LR, RINA, ISA 12.12.01, ATEX, IECEx)

Type	Qty.	Order No.
AMG ELM-8F EX	1	2082320000
AMG ELM-10F EX	1	2082430000

Type	Qty.	Order No.
AMG DIS	10	2123050000
AMG MD	10	2122930000
AMG OD	10	2122910000
AMG PD	10	2122920000

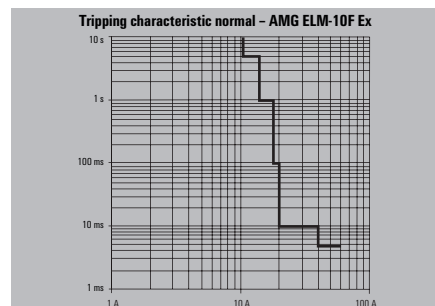
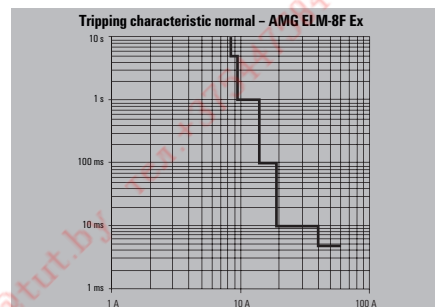

maxGUARD

maxGUARD – load monitoring adjustable

Electronic load monitoring with adjustable triggering current and triggering characteristic

Technical data

Input	
Input fuse (internal)	Yes
DC input voltage range	18...30 V DC
Rated input voltage	24 V DC
Current consumption (idle)	25 mA
Current consumption (full load)	I _{OUT} +30 mA
max. admissible residual ripple at the input	100 mVpp
Output	
Connection system	PUSH IN
Triggering characteristic	see characteristic curve
Backup modes	1- 6 A
Switch-on delay	1 s
Capacitive load	15,000 µF
adjustable rated current	Yes
Surge protection	Suppressor diode
Function key	
LED initial state	LED green, in operation
Pressing the button	> 0.1 to 2 s (manual disconnect)
LED, subsequent state	LED flashing red, load monitoring has triggered (disconnected)
Output, subsequent state	LED red (permanently lit)
General data	
Relay to activate the output	No
Protection degree	IP20
Overvoltage category	III
Signalling	
LED green	Operation (failure-free), Early warning: I _{Out} > 90% I _{Rated} (flashing)
LED red	Load monitoring has disconnected, Load monitoring has triggered (flashing), Internal error (rapid flashing)
Connection data	
Number of terminals	2 (+ / -)
Wire cross-section, AWG/kcmil min/max	26...12
Wire cross-section, flexible min/max	0.14...2.5 mm ²
Wire cross-section, rigid min/max	0.14...2.5 mm ²
Screwdriver blade	0.6 x 3.5
Approvals	
Approvals	CE (in preparation: TÜV (60950), cULus, UL 2367, GL-DNV, BV, ABS, LR, RINA, ISA 12.12.01, ATEX, IECEx)
Note	

Ordering data

Rated current	6.00 A
Note	

Accessories

Type	Qty.	Order No.
AMG DIS	10	2123050000
AMG MD	10	2122930000
AMG OD	10	2122910000
AMG PD	10	2122920000
Note		

AMG ELM-6 Ex

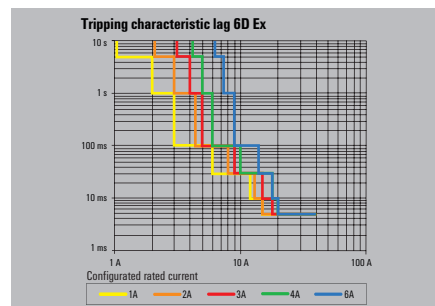
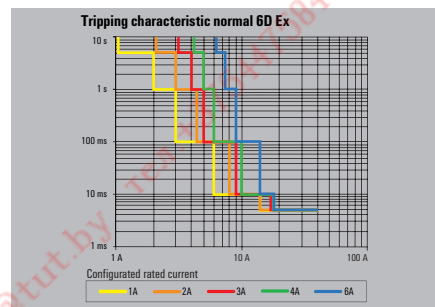
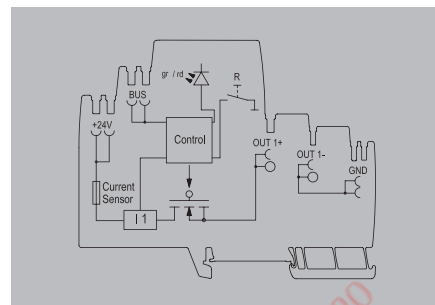

Type	Qty.	Order No.
AMG ELM-6 EX	1	2082000000
Type	Qty.	Order No.
AMG DIS	10	2123050000
AMG MD	10	2122930000
AMG OD	10	2122910000
AMG PD	10	2122920000
Note		

maxGUARD – load monitoring adjustable

Electronic load monitoring with adjustable trigger current and characteristic (with I > 90 % pre warning)

AMG ELM-12 Ex

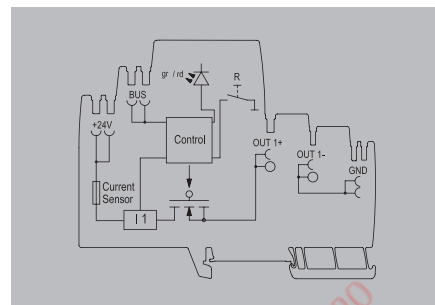

Technical data

Input

- Input fuse (internal)
- DC input voltage range
- Rated input voltage
- Current consumption (idle)
- Current consumption (full load)
- max. admissible residual ripple at the input

Output

- Connection system
- Triggering characteristic
- Backup modes

- Switch-on delay
- adjustable rated current
- Capacitive load
- Surge protection

Function key

LED initial state

Pressing the button

LED, subsequent state
Output, subsequent state

General data

- Relay to activate the output
- Protection degree
- Overvoltage category

Signalling

- LED green
- LED red

Connection data

- Number of terminals
- Wire cross-section, AWG/kcmil min/max
- Wire cross-section, flexible min/max
- Wire cross-section, rigid min/max
- Screwdriver blade

Approvals

Approvals

Note

Ordering data

Rated current 12.00 A

Note

Accessories

Note

Input

- Yes
- 18...30 V DC
- 24 V DC
- 25 mA
- I_{OUT} +30 mA
- 100 mVpp

Output

- PUSH IN
- see characteristic curve
- 4-12 A

1 s

Yes

20,000 µF

Suppressor diode

LED green, in operation	LED flashing red, load monitoring has triggered (disconnected)	LED red (permanently lit)
-------------------------	--	---------------------------

> 0.1 to 2 s (manual disconnect)	> 0.1 to 2 s (confirm and reset)	> 0.1 to 2 s (restart)
----------------------------------	----------------------------------	------------------------

Red LED switched off	Red LED switched off	LED green switched on
----------------------	----------------------	-----------------------

General data

- No
- IP20
- III

Signalling

Operation (failure-free), Early warning: I_{Out} > 90% I_{Rated} (flashing)

Load monitoring has disconnected, Load monitoring has triggered (flashing), Internal error (rapid flashing)

Connection data

- 4 (++ / -)
- 26...12
- 0.14...2.5 mm²
- 0.14...2.5 mm²
- 0.6 x 3.5

Approvals

CE (in preparation: TÜV (60950), cULus, UL 2367, GL-DNV, BV, ABS, LR, RINA, ISA 12.12.01, ATEX, IECEx)

Note

Ordering data

Type	Qty.	Order No.
AMG ELM-12 EX	1	2082010000

Accessories

Type	Qty.	Order No.
AMG DIS	10	2123050000
AMG MD	10	2122930000
AMG OD	10	2122910000
AMG PD	10	2122920000

Tripping characteristic normal Ex

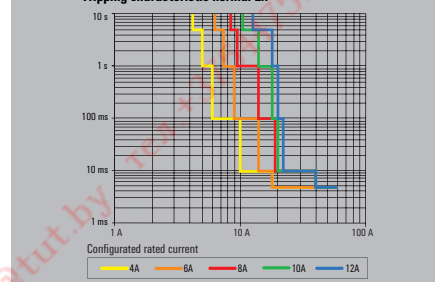

Tripping characteristic lag

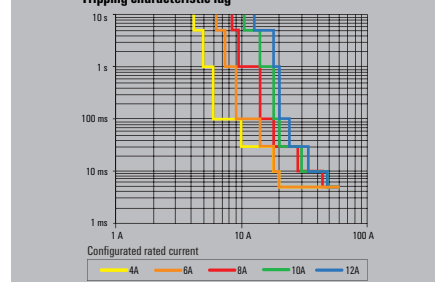

maxGUARD

maxGUARD – Alarm module

Alarm module with potential-free contacts for the “Alarm” and “I>90%” signals.

AMG AM CO

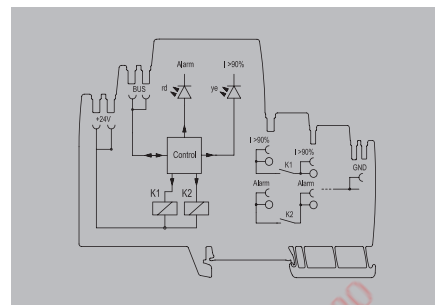

Technical data

Input	
Input fuse (internal)	No
DC input voltage range	18...30 V DC
Rated input voltage	24 V DC
Current consumption (idle)	25 mA
Current consumption (full load)	30 mA
max. admissible residual ripple at the input	100 mVpp
Surge protection	Suppressor diode
General data	
Protection degree	IP20
Overvoltage category	III
Signalling	
LED yellow	Current > 90% Inom (flashing)
LED red	Alarm
Floating contact	Yes
Status relay (max. load)	Alarm (24 V / 0.1 A), I > 90% (24 V / 0.1 A)
Connection data	
Number of terminals	4 (2x NO)
Wire cross-section, AWG/kcmil min/max	26...12
Wire cross-section, flexible min/max	0.14...2.5 mm ²
Wire cross-section, rigid min/max	0.14...2.5 mm ²
Screwdriver blade	0.6 x 3.5
Approvals	
Approvals	CE (in preparation: TÜV (60950), cULus, UL 2367, GL-DNV, BV, ABS, LR, RINA, ISA 12.12.01, ATEX, IECEx)

Note

Ordering data

Rated current

Note

Type	Qty.	Order No.
AMG AM CO	1	2082770000

Accessories

Pluggable cross-connection	
50-pole	
50-pole / red	
50-pole / blue	
2-pole	
2-pole / red	
2-pole / blue	
Note	

Type	Qty.	Order No.
ZQV 4N/50	5	1528130000
ZQV 4N/50 RD	5	2460730000
ZQV 4N/50 BL	5	1528240000
ZQV 4N/2	60	1527930000
ZQV 4N/2 RD	60	2460450000
ZQV 4N/2 BL	60	1528040000

maxGUARD – control module

Control module with extended control function: Alarm, Reset, I>90%, ON/OFF

AMG CM Ex

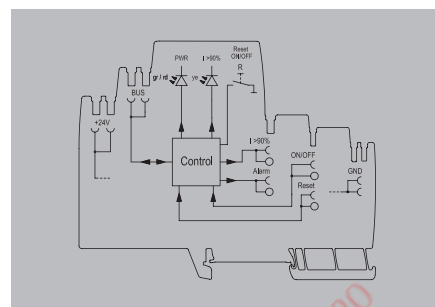

Technical data

Input	
DC input voltage range	18...30 V DC
Rated input voltage	24 V DC
Current consumption (idle)	25 mA
Current consumption (full load)	225 mA
max. admissible residual ripple at the input	100 mVpp
Output	
Connection system	PUSH IN
Surge protection	Suppressor diode
General data	
Relay to activate the output	No
Protection degree	IP20
Control inputs	ON/ OFF, Reset
Overvoltage category	III
Signalling	
LED green	Operation (failure-free), Early warning: I Out > 90% I Rated (flashing)
LED red	Load monitoring has disconnected, Load monitoring has triggered (flashing), Internal error (rapid flashing)
Transistor output, positive-switching	Pre-warning, Alarm
Connection data	
Number of terminals	2 (Reset / ON)
Wire cross-section, AWG/kcmil min/max	26...12
Wire cross-section, flexible min/max	0.14...2.5 mm ²
Wire cross-section, rigid min/max	0.14...2.5 mm ²
Screwdriver blade	0.6 x 3.5
Approvals	
Approvals	CE (in preparation: TÜV (60950), cULus, UL 2367, GL-DNV, BV, ABS, LR, RINA, ISA 12.12.01, ATEX, IECEx)
Note	

Ordering data

Rated current	
Note	

Accessories

Pluggable cross-connection	
50-pole	
50-pole / red	
50-pole / blue	
2-pole	
2-pole/ red	
2-pole / blue	
Note	

Technical data		
DC input voltage range	18...30 V DC	
Rated input voltage	24 V DC	
Current consumption (idle)	25 mA	
Current consumption (full load)	225 mA	
max. admissible residual ripple at the input	100 mVpp	
Output		
Connection system	PUSH IN	
Surge protection	Suppressor diode	
General data		
Relay to activate the output	No	
Protection degree	IP20	
Control inputs	ON/ OFF, Reset	
Overvoltage category	III	
Signalling		
LED green	Operation (failure-free), Early warning: I Out > 90% I Rated (flashing)	
LED red	Load monitoring has disconnected, Load monitoring has triggered (flashing), Internal error (rapid flashing)	
Transistor output, positive-switching	Pre-warning, Alarm	
Connection data		
Number of terminals	2 (Reset / ON)	
Wire cross-section, AWG/kcmil min/max	26...12	
Wire cross-section, flexible min/max	0.14...2.5 mm ²	
Wire cross-section, rigid min/max	0.14...2.5 mm ²	
Screwdriver blade	0.6 x 3.5	
Approvals		
Approvals	CE (in preparation: TÜV (60950), cULus, UL 2367, GL-DNV, BV, ABS, LR, RINA, ISA 12.12.01, ATEX, IECEx)	
Note		

Type	Qty.	Order No.
AMG CM EX	1	2083360000

Type	Qty.	Order No.
ZQV 4N/50	5	1528130000
ZQV 4N/50 RD	5	2460730000
ZQV 4N/50 BL	5	1528240000
ZQV 4N/2	60	1527930000
ZQV 4N/2 RD	60	2460450000
ZQV 4N/2 BL	60	1528040000

maxGUARD

maxGUARD – Potential distributor

Potential distribution in combination with the electronic load monitoring.

AMG

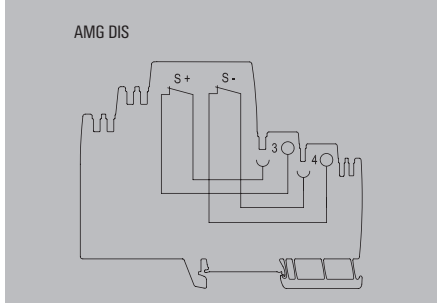
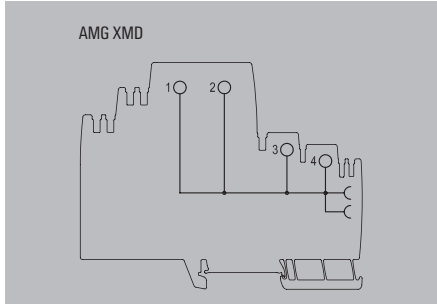
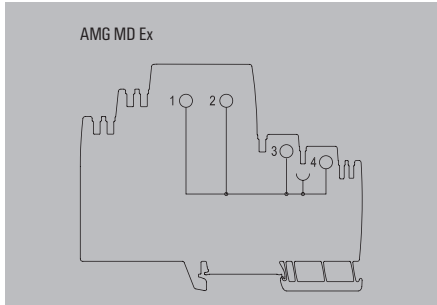
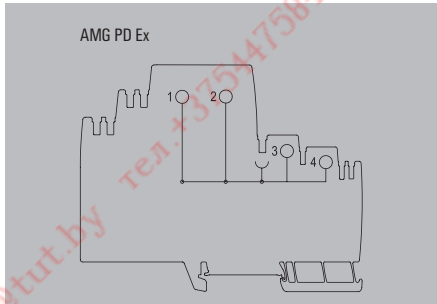
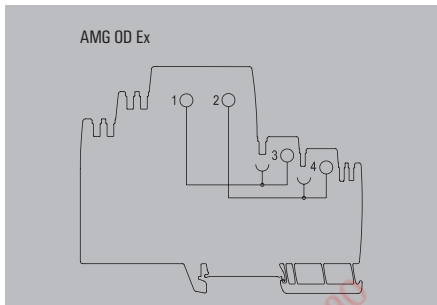
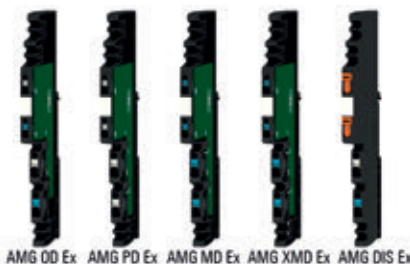

Technical data

General data	
Protection degree	IP20
Total current load per potential	2495090000: 12 A; 2495070000: 12 A; 2495040000: 12 A; 2495080000: 24 A; 2495100000: 12 A
Current load per contact point	12 A
Connection data	
Connection system	PUSH IN
Number of terminals	2 x 1.5 mm ² , 2 x 2.5 mm ²
Wire cross-section, AWG/kcmil min/max	26...12
Wire cross-section, flexible min/max	0.14...2.5 mm ²
Wire cross-section, rigid min/max	0.14...2.5 mm ²
Screwdriver blade	0.6 x 3.5
Approvals	
Approvals	CE (in preparation: TÜV (60950), cULus, UL 2367, GL-DNV, BV, ABS, LR, RINA, ISA 12.12.01, ATEX, IECEx)
Note	

Ordering data

Type	Qty.	Order No.
AMG OD EX	1	2495090000
AMG PD EX	1	2495070000
AMG MD EX	10	2495040000
AMG XMD EX	1	2495080000
AMG DIS EX	1	2495100000
Note		

Accessories

Pluggable cross-connection	
50-pole	ZQV 4N/50
50-pole / red	ZQV 4N/50 RD
50-pole / blue	ZQV 4N/50 BL
2-pole	ZQV 4N/2
2-pole / red	ZQV 4N/2 RD
2-pole / blue	ZQV 4N/2 BL
Note	

Type	Qty.	Order No.
ZQV 4N/50	5	1528130000
ZQV 4N/50 RD	5	2460730000
ZQV 4N/50 BL	5	1528240000
ZQV 4N/2	60	1527930000
ZQV 4N/2 RD	60	2460450000
ZQV 4N/2 BL	60	1528040000
Note		

Г.Мінск www.fotoreport.by

maxGUARD – accessories

Cross-connector orange



Type	Qty.	Order No.
ZQV 4N/2	60	1527930000
ZQV 4N/3	60	1527940000
ZQV 4N/4	60	1527970000
ZQV 4N/5	60	1527980000
ZQV 4N/6	20	1527990000
ZQV 4N/7	20	1528020000
ZQV 4N/8	20	1528030000
ZQV 4N/9	20	1528070000
ZQV 4N/10	20	1528090000
ZQV 4N/50	5	1528130000

Cross-connector blue



Type	Qty.	Order No.
ZQV 4N/2 BL	60	1528040000
ZQV 4N/3 BL	60	1528080000
ZQV 4N/4 BL	60	1528120000
ZQV 4N/5 BL	60	1528140000
ZQV 4N/6 BL	20	1528170000
ZQV 4N/7 BL	20	1528180000
ZQV 4N/8 BL	20	1528190000
ZQV 4N/9 BL	20	1528220000
ZQV 4N/10 BL	20	1528230000
ZQV 4N/50 BL	5	1528240000

Cross-connector red



Type	Qty.	Order No.
ZQV 4N/2 RD	60	2460450000
ZQV 4N/3 RD	60	2460810000
ZQV 4N/4 RD	60	2460800000
ZQV 4N/5 RD	60	2460790000
ZQV 4N/6 RD	20	2460780000
ZQV 4N/7 RD	20	2460770000
ZQV 4N/8 RD	20	2460760000
ZQV 4N/9 RD	20	2460750000
ZQV 4N/10 RD	20	2460740000
ZQV 4N/50 RD	5	2460730000

maxGUARD – accessories

End plate and Separation plate



Type	Qty.	Order No.
AMG PP	40	2123000000
AMG EP	30	2495380000
AMG EP KIT	1	2500760000

End brackets



Type	Qty.	Order No.
WEW 35/2 SW	100	1061210000
WEW 35/2 V0 GF SW	100	1479000000

Cutting tool for ZQV



Type	Qty.	Order No.
KT 14	1	1157820000

г. Минск www.fotorele.net www.tiristor.by email minsk17@tut.by тел. +375447584780

Electrical cabinet socket outlet

Electrical cabinet socket outlet

Electrical cabinet socket outlet

D.2

г. Минск www.fotorele.net www.tiristor.by email minsk17@tut.by тел. +375447584780

D

Electrical cabinet socket outlet

Electrical cabinet socket outlet

- Simple installation in electrical cabinet
- TS 35 module can be mounted on rail
- VDE mark of conformity
- Two-pole with earthing contact

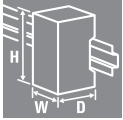

Schuko TS35

D

Technical data

Rated voltage
 Rated voltage, max.
 Rated current
 Clamping range, nom.
 Tightening torque
 Ambient temperature (operational)
 Overvoltage category
 Pollution degree
 Protection degree
 Approvals

230 V
 250 V
 16 A
 1 mm²-1.5 mm²
 1.3 Nm
 -20...40 °C
 II
 2
 VDE

Dimensions

Clamping range (nominal / min. / max.) mm²
 Depth x width x height

1.5 / 1 / 1.5
 / 76 / 45

Note

Ordering data

Type	Qty.	Order No.
Schuko TS35	10	8734580000

Note

Accessories

Note

www.tiristor.by email minsk17@tut.by тел. +375447584780

Service and support

Service and support	Our expertise for your requirements	V.2
	Benefit from optimum support when using our products	V.4

г. Минск www.fotorele.net www.tiristor.by email minsk17@tut.by тел. +375447584780

Our expertise for your requirements

Service connects – worldwide

Automation technology functions are becoming more complex in a globally-oriented world facing ambitious targets in terms of energy efficiency and smart production. We are your equal partners for the best connections in Industrial Connectivity. Our worldwide network of industrial managers for machine construction, process automation, energy and traffic engineering and for device manufacturers know the challenges you face and can support you in your specific applications.

Training course on technologies, applications and the detailed functionality of our products is available to you locally or at our headquarter in Germany. Our personal support can answer any questions reliably and expertly. Our online services are available 365 day a year around the clock to provide answers to your questions on our products - from user documentation through software to planning tools.

In short: Weidmüller's global service combines our expertise with your requirements.





Professional advice on planning

Our global network of industrial managers has extensive experience in automation technology and electrical connectivity. This expertise allows us to assist you with advice and planning support in order to work with you on resolving the everyday challenges of your applications.



Technology and application training

Industrial automation is moving towards smart production. It faces the challenges of new technologies and applications. Our varied range of training courses develops this knowledge further or provides more in-depth information on the handling of our products and solutions. Our seminars are modular and can be customised. We can train you and your employees in our academy, on your premises if you wish or online in our webinars at any time.



Customised installation

The challenges for the future are reducing costs and increasing efficiency. This requires intelligent, individual solutions which are tailored to your requirements. We can offer a highly qualified customer-specific production service in our application centre. Whether you need modified products, pre-assembled terminal rails or complete small cabinets: we produce the solutions developed for your application quickly and flexibly.



Online and personal support

From planning through installation to operation, we can provide exactly the right help and information for each step of your application based on our solutions and products: up-to-date, uncomplicated and comprehensive, around the clock, online or in person.



Visit our website for more information

www.weidmueller.com/service

Let's connect.

Benefit from optimum support when using our products

Service connects – worldwide

If our products are used in your automation technology applications, you need the best possible individual support, from planning through installation to operation.

For every stage of your application, we can offer the right tools and information for our products and solutions. Up-to-date, uncomplicated, comprehensive and around the clock via our service portal at www.weidmueller.com/service.

Fast access to our support and services is available via Weidmüller webcodes. Simply select the service you want on the right hand side, then enter the webcode made up of five digits with a preceding hashtag into the search field in the top right corner of www.weidmueller.com and it will bring up the details you need.

Online support and downloads

Exactly the right help and information on our solutions and products

From selection through to operation of our solutions and products in your application, you can access our web portal at any time, with a wide range of information material, software, product configurators and much more.

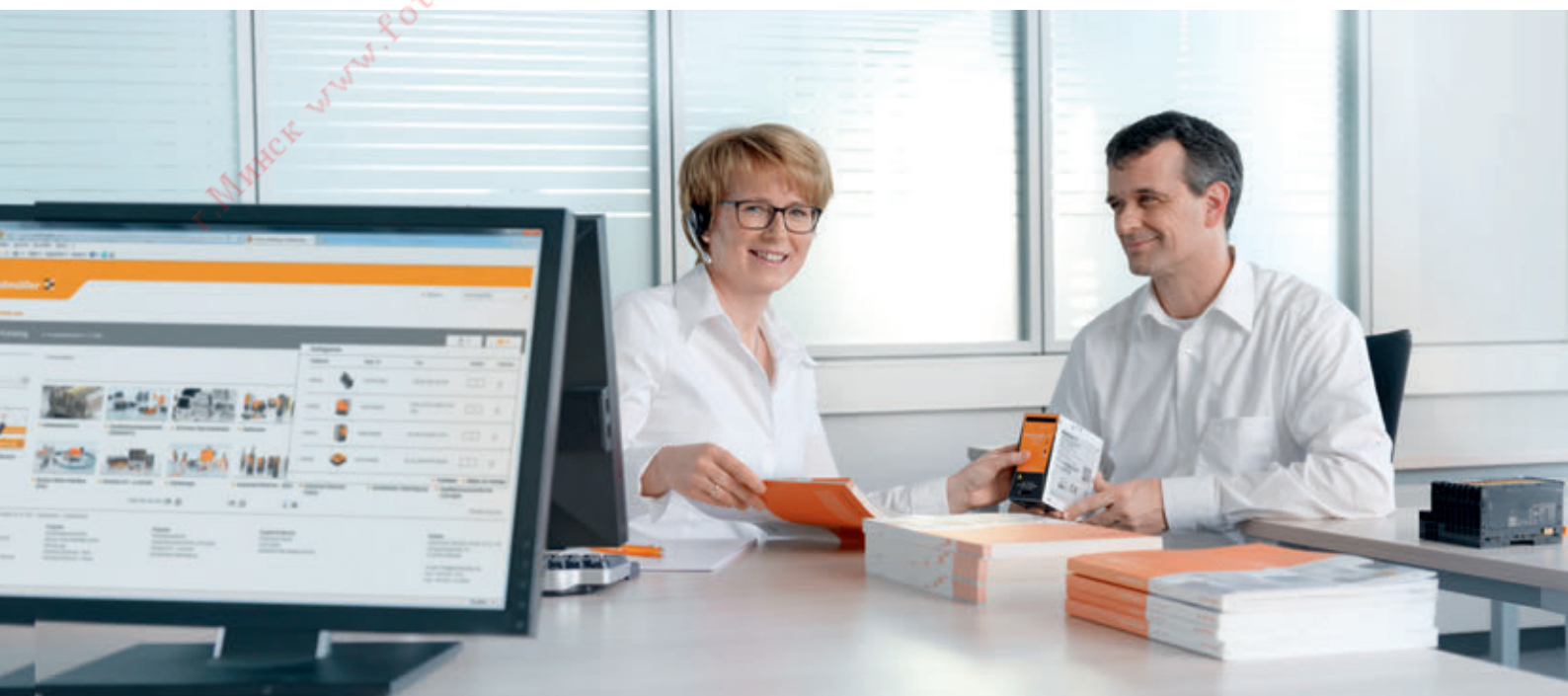

Engineering Support

As a developer, you need simple processes and system-wide tools. We support you in your development environment with comprehensive data, software tools and interfaces, product selection guides and development samples.



Engineering data

Webcode #01219



Product software

Webcode #01212



Whitepaper for device connectivity

Webcode #11359



Engineering software

Webcode #11377



Product configurators, product selection guides and samples

Webcode #01214

Technical data and downloads

Download all the documents and software relating to our products by simply entering the item number. You can also view our Online Catalogue and research the technical properties of our products.



Find downloads

Webcode #11379



Products in the Online Catalogue

Webcode #01217



Electronic catalogue in BMECat format and other formats

Webcode #11378



Access our Webshop

Webcode #11382



Technical catalogue in PDF Format

Webcode #01218

More offers in online support and downloads

Not found what you are looking for? We have even more to offer you in online support and downloads.



Approvals, certificates and declaration of conformity

Webcode #11374

Here you will find information on the CE declaration of conformity, on RoHS and REACH and other company related certificates and approvals.

г. Минск www.fotorele.net www.tiristor.by email minsk17@tut.by тел. +375447584780

V

Glossary/Technical appendix

Glossary/Technical appendix	Power Supplies - Overview	W.2
	Standards and approvals	W.4
	Glossary	W.6

г. Минск www.fotorele.net www.tiristor.by email minsk17@tut.by тел. +375447584780

Power Supplies – Overview

Power supplies are important links in the energy supply chain of automation systems. Unregulated power supplies or regulated switched-mode power supplies are at the heart of every electrical cabinet. 24 V DC has emerged as the standard control voltage for the supply of electrical sub-assemblies and systems. But other control voltages are also required. The correct power supply is a critical factor for the reliable operation of the supplied components. Thus it must be chosen with particular attention.

Power supplies from Weidmüller, whether regulated or unregulated, have proven themselves reliable over many years in the supply of electrical sub-assemblies and systems. They perform reliably and safely – even under harsh industrial conditions – in all sectors of machine construction, industrial automation, and the power and process industries.

Weidmüller offers custom-fit solutions for practically all of your requirements:

- Unregulated transformer power supplies
- Primary switch-mode power supplies
- DC/DC converters
- Diode modules
- UPS control modules
- Electronic fusing

How they work

Unregulated power supply units consist of a mains power transformer that transforms the input voltage into a different AC voltage. The units then make use of a rectifier and a filter circuit to smooth out the DC output voltage.

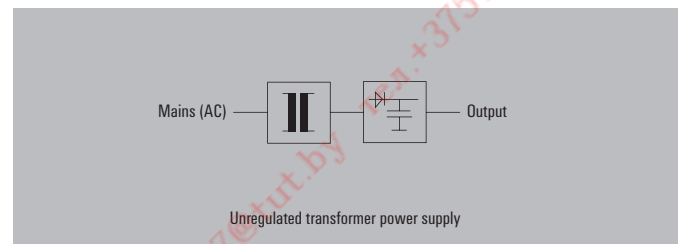

Regulated power supply units in the range up to 1,000 W are usually designed as primary switched-mode power units. The mains AC voltage is then rectified and transformed in high frequency to the secondary side using switching transistors and power transformers. This is followed by the rectifier and filter circuit in order to generate the DC output voltage. A control circuit compares the current and voltage on the output side to the specified target values and then generates a control signal for the switching transistors. This permits compensation for load changes and mains voltage fluctuations. As a result, the output voltage remains stable. These power supply units are increasingly being operated with DC input voltages (for example, Weidmüller's PRO-M line of switched-mode power supplies).

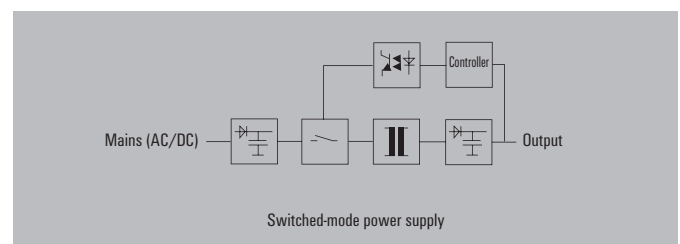

A DC/DC converter is a variation of the classic switched mode power supply. The switching strategy is similar but there is no input rectifier. Starting with a specified DC input voltage, DC/DC converters generate a different DC voltage at a similar or different level. They are used to adapt different voltage levels and also for isolating potentials.

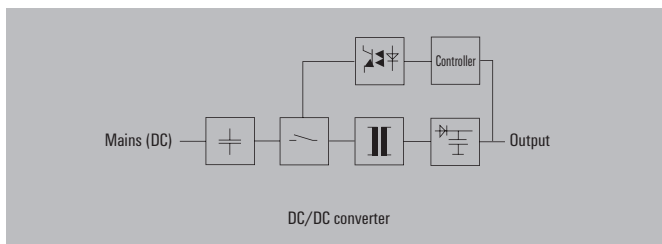

In use around the globe

Weidmüller's power supply units have been designed for use around the world. They can be used in practically all applications throughout the world because of their CE label and many other national and international approvals. Their wide input voltage ranges and compatibility with various mains power connections increases their global appeal.

Temperature range

During operation, power supply units generate power losses. In Weidmüller's switched-mode power supplies, the resulting heat is dispersed using natural air currents only. The design, which does not make use of a ventilation fan, is an example of our uncompromised durability standard. Weidmüller's power supply units, depending on the model, can be used in temperatures ranging from -25 °C to +70 °C.

Compact and efficient design

Weidmüller's switched-mode power supplies are extra small because they take advantage of the above-average degree of efficiency offered by the latest technologies. The power supplies from Weidmüller – whether they are book-shaped with minimised base surface, or variants with reduced height for use in distributor boxes – always provide the proper cost-saving solution.

Standards and approvals

Standard/Approval	Description
DIN EN 50178 (VDE 0160)	Electronic equipment for use in power installations
DIN EN 60950-1 (VDE 0805-1)	IT Equipment – Safety – Part 1: General requirements
DIN EN 61558-1 (VDE 0570-1)	Safety of transformers, power supply units, throttles and similar devices Part 1: General requirements and tests
DIN EN 61558-2-17 (VDE 0570 Part 2-17)	Safety of transformers, power supply units and similar devices Part 2-17: Special requirements for switch-mode power supply transformers
DIN EN 60204-1 (VDE 0113-1)	Safety of machinery – Electrical equipment of machinery – Part 1: General requirements
DIN VDE 0100-410	Construction of power installations with rated voltages up to 1,000 V Part 4: Protective measures Chapter 41: Protection against electrical shock
DIN EN 61204-1	Power supply units for low voltages, with direct-current-output – properties
DIN EN 60947-1	Low-voltage switching devices – Part 1: General definitions
DIN EN 61140	Protection against electrical shock - common requirements for facilities and operating equipment
IEC 38	Supplementary notes relating to status of international standards and European harmonisation of mains voltages 230/400 V
73/23 EWG	Electrical equipment for use within specific voltage limits (Low Voltage Directive)
2004/108/EG (89/336 EWG)	Electromagnetic compatibility (EMC Directive)
2006/42/EG (98/37 EG)	Safety of machines (directive covering mechanical equipment)
UL	Safety approval for the United States market
CSA	Safety approval for the Canadian market
GL	Test specifications for electrical/electronic devices and systems for use in marine technology
UL1310	Class 2 power supplies (limited energy)
UL1604	Electrical equipment for use in dangerous surroundings

Standard/Approval	Description
SEMI F47	Resistance of electronic devices against voltage drops
2006/95/EG (72/23/EWG)	Low Voltage Directive
EN 60721-3-2	Classification of surrounding conditions
EN 60664-1 (VDE0110-1)	Insulation coordination for electrical equipment
C22.2 No. 107.1	General standards for power supplies (Canadian standard)
EN 61000-3-2	Limiting of mains voltage harmonic currents
EN 61000-4-x	Interference immunity tests

г. Минск www.fotorele.net www.tiristor.by email: minsk17@tnt.by tel: +375447584780

Glossary

A

AC/DC converter	Conventional switched-mode power supplies generate a DC voltage from an AC voltage. For this reason they are sometimes also called AC/DC converters. Such devices are increasingly compatible for use with DC input voltages. The primary and secondary sides are typically electrically isolated.
Ambient temperature (operational)	The ambient operating temperature (the min. and max. values) together with the output current and voltage ratings can be used to describe the power capabilities of a power supply unit.

B

Burst	A burst is a quick low-power burst pulse which can, for example, simulate welding equipment phenomena. Similar phenomena can also result from switching operations on the mains supply. This test can be used to demonstrate immunity against quick transients.
--------------	---

C

Class of protection	Electrical equipment is classified according to varying classes of protection. These classes define the particular safety measures that are required to avoid an electrical shock. The most widely used power supplies correspond with protection class I. The basic requirement of protection class I is for a basic insulation and for the earthing of all conductive housing parts. If the basic insulation fails, then the earthed conductive housing serves to prevent an electrical shock. For this reason, devices in protection class I are equipped with an earth (PE) connection.
Connecting power supply units in parallel	Power supplies can only be connected in parallel when this is clearly permitted by the manufacturer. Parallel connections are then normally tied to certain conditions. This is a typical way to increase the output power (for example, when extending a facility). Power supplies are also wired in parallel in order to design in redundant power supply systems. The parallel circuit is not wired straight though but connects using decoupling diodes. → Redundancy
Cooling	Cooling is used by components or devices to prevent them from overheating. A variety of cooling strategies are available – two of the most common are natural and forced-air cooling. Natural (convection-based) cooling takes advantage of the natural air currents. Manufacturers must then ensure that there is sufficient air flow by specifying the clearance gaps and mounting positions that are required above and below the ventilation openings. Forced-air cooling normally uses a fan to dissipate any heat that has been generated. When fans are used in a device, they have the effect of increasing the likelihood of device outages. For this reason, a power supply with natural cooling methods is generally preferred.

D

DC/DC converter	DC/DC converters are switched-mode power supplies that convert a specific DC voltage into another voltage. They are a variant of the AC/DC converter. DC/DC converters, in their simplest implementation, do not isolate voltage potentials. They are used only for adapting voltages. Improved DC/DC converters have isolated voltages. A safety isolating transformer in the power element ensures the required electrical isolation. Besides the voltage adaptation, the isolation of the voltage potentials is an important factor.																																
Derating	<p>For power supply devices, derating generally refers to the reduction in power as influenced by the surrounding temperature and the input voltage. A temperature derating often occurs starting at a surrounding temperature of 50 °C. The rated power is guaranteed up to this temperature. The available power continually declines as the temperature heats up above this level. This is typically specified in %/K. A voltage-dependent specification is another form of derating. For switched-mode power supplies, the derating begins below a specific input voltage. So a switched-mode power supply with a wide input range can typically work under full power with 115 V AC input voltage. However at 85 V AC it can only produce 60 % of the power rating. The coefficient is usually specified in %/V.</p> <div style="display: flex; justify-content: space-around;"> <div data-bbox="624 1115 978 1361"> <p style="text-align: center;">Temperature derating</p> <table border="1"> <caption>Temperature derating data</caption> <thead> <tr> <th>Temperature [°C]</th> <th>Max. current [%IN]</th> </tr> </thead> <tbody> <tr><td>40</td><td>100</td></tr> <tr><td>50</td><td>100</td></tr> <tr><td>60</td><td>100</td></tr> <tr><td>70</td><td>80</td></tr> </tbody> </table> </div> <div data-bbox="1066 1115 1434 1361"> <p style="text-align: center;">Voltage derating</p> <table border="1"> <caption>Voltage derating data</caption> <thead> <tr> <th>Main voltage [V]</th> <th>Max. current [%IN]</th> </tr> </thead> <tbody> <tr><td>85</td><td>60</td></tr> <tr><td>115</td><td>100</td></tr> <tr><td>130</td><td>100</td></tr> <tr><td>150</td><td>100</td></tr> <tr><td>170</td><td>100</td></tr> <tr><td>190</td><td>100</td></tr> <tr><td>210</td><td>100</td></tr> <tr><td>230</td><td>100</td></tr> <tr><td>250</td><td>100</td></tr> <tr><td>270</td><td>100</td></tr> </tbody> </table> </div> </div>	Temperature [°C]	Max. current [%IN]	40	100	50	100	60	100	70	80	Main voltage [V]	Max. current [%IN]	85	60	115	100	130	100	150	100	170	100	190	100	210	100	230	100	250	100	270	100
Temperature [°C]	Max. current [%IN]																																
40	100																																
50	100																																
60	100																																
70	80																																
Main voltage [V]	Max. current [%IN]																																
85	60																																
115	100																																
130	100																																
150	100																																
170	100																																
190	100																																
210	100																																
230	100																																
250	100																																
270	100																																
Diode modules	Diode modules are used to construct a redundant power supply system. They are important for decoupling the power supply unit. Thus, a short circuit that occurs on the output of a power supply unit will not influence the output voltage.																																

E

Efficiency	The degree of efficiency is equal to the ratio of output power to input power and is expressed in percent. The degree of efficiency can be between 70 and 90 %, depending on the dimensions and type of technology in use.
EMC (electromagnetic compatibility)	Electromagnetic compatibility describes the interference emissions caused by an electronic device and the level of immunity against external electrical influences. Interference emissions can be caused by cabling and wires or by radiated emissions. Immunity measures the resistance against such wire-based emissions and against radiated emissions such as electrostatic fields and magnetic fields. Electric devices must also be protected against electrostatic discharges.

F

Foldback characteristic curve

The foldback characteristic curve is a special type of output curve that protects the power supply unit from overloads. When a specific current limit is exceeded (for example, by 110 or 120 % of the nominal level), the current is limited electronically and lowered to a very low, safe value. This downward-sloping characteristic curve means that it is not sufficient to simply eliminate the overload. The load must be reduced significantly more so that the adjustment control can return to the normal voltage control. Thus this solution is not suitable for many applications and is becoming less popular.

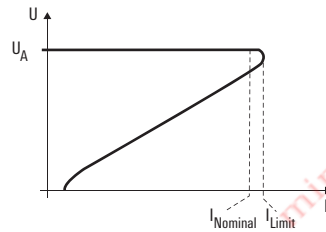

G

Galvanic isolation

Galvanic (electrical) isolation ensures that no electrical connections can exist between the primary and the secondary sides. Opto modules and transformers are the typical components used.

H

Hiccup mode

The hiccup mode is a special output characteristic curve that protects power supply units from overloads and short circuits. The unit switches off at a specified current limit (for example, 110 or 120 % on the nominal rating) and then switches back on after a certain delay. This leads to a pulsating mode of operations which can only revert to continual operations after the overload has been eliminated. The main disadvantage here is that the connected consumer load must be restarted after every pause. A restart may not be possible with motors or large capacitive loads since the restart current peak may once again exceed the defined limit.

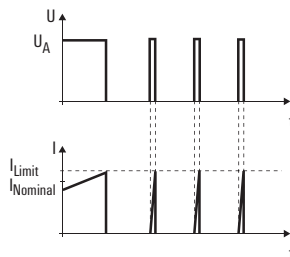

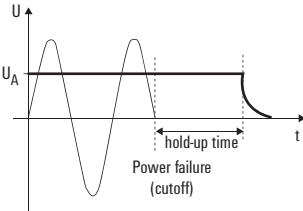
<p>Hold-up time (mains-failure bridging time)</p>	<p>The hold-up time (also known as the mains-failure bridging time) is the interval from the start of the mains outage to the point in time when the output voltage can no longer be maintained at its original level. The hold-up time indicates how long a mains outage may last before it influences the output voltage. For DC power supplies, EN 61204 requires a bridging time of at least 20 ms.</p>  <p>The graph shows a sinusoidal input voltage U on the y-axis and time t on the x-axis. A horizontal line represents the output voltage U_A. A vertical dashed line marks the start of a 'Power failure (cutoff)'. The output voltage U_A remains constant for a duration labeled 'hold-up time' before it begins to decay.</p>
<p>I</p>	
<p>Input voltage range</p>	<p>This refers to the minimum and maximum input voltage at which the rated output specifications can be maintained.</p>
<p>Inrush current</p>	<p>The inrush current refers to the peak current that occurs when turning on a consumer load. Switched-mode power supplies have storage capacitors in the input which can cause significant current peaks while the mains power is being switched on. A variety of circuitry solutions can be used to attenuate these current peaks. In the simplest solution, an inrush limiter is used. Active switching can be used in other cases. The peak current specification indicates which upstream fuse should be used in the circuit. If a fuse is selected which is too sensitive, it can trigger when the mains power is switched on.</p>

IU characteristic curve

The IU characteristic curve is a special output characteristic curve that protects power supply units from overloads and short circuits. It offers the best performance with regards to overload and short circuit capabilities. A current limit is activated at a specific current level (for example, 110 or 120 % on the nominal rating). As the load continues to increase, the output voltage is reduced according to the current limit curve until it reaches a level approaching zero volts. Thus a pulsating mode of operations is avoided for short-term overloads. Large capacitive loads or motors are brought back up along the slope of the current-limit characteristic curve. After a short circuit or overload is fixed, the IU characteristic curve offers the advantage of immediately returning to the normal voltage control mechanism. The full output voltage is then immediately available. The IU characteristic curve is becoming the established standard for modern power supplies. Additional variants are available which pertain to the peak current capacity and the slope of the current-limit characteristic curve.

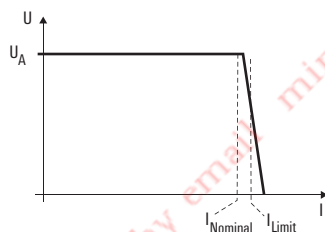

M

Mains harmonics

Power supplies can experience harmonics caused by mains rectification on the input side. These harmonics are multiples of the mains frequencies. Existing standards define specific limit values since such harmonics can significantly lower the mains quality.

Mains system types

This refers to the types of mains supply systems. Systems differ in their method of earthing and the implementation of the phase wire, PE wire and central-point wire. Common mains systems include the TN, IT and TT networks. The individual mains types can also differ in their voltage levels and frequencies.

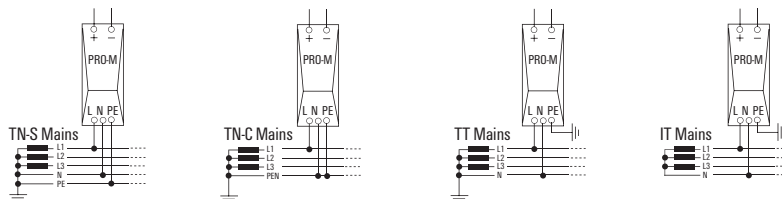

W

MTBF (mean time between failure)

The MTBF is a statistical value that specifies the probability that a product will fail. It is typically specified in hours and normally assumes a temperature of 25 °C. The probability of failure depends largely on the ambient surroundings. The key variables are the type of load and the ambient temperature.

O

Output characteristic curves	<p>The output characteristic curves of power supply devices are determined by current and voltage. Unregulated devices do not have a current limit. In the case of an overload or short circuit, fuses or temperature switches are used to protect the device. Regulated devices are protected against overload and short circuits by means of various output characteristic curves. In this case, the system attempts to prevent any activation of fuses or temperature switches.</p> <p>The mandatory manual reset which follows an overload or short circuit can then be avoided. Common output characteristic curves include the hiccup mode, the foldback characteristic curve or the IU characteristic curve.</p> <p>→ Hiccup mode, foldback characteristic curve, IU characteristic curve</p>
Overvoltage category	<p>Power supply units are classified into overvoltage categories according to the immunity against mains surges and transient voltages.</p>

P

PELV (protective extra-low voltage)	<p>This is a functional DC voltage with secure isolation according to EN 50178. As with SELV, a reinforced or double insulation is used between the primary and secondary sides. However, the secondary side is earthed.</p>
PFC (power factor correction)	<p>The power factor correction can be either passive or active in relation to power supply devices. The reactive power resulting from the bridge rectification puts a significant strain on the power supply network. The relatively poor power efficiency factor that results can be improved by using passive components (such as filters) or an active electronic mechanism. For switched-mode power supplies, PFC usually refers to the active variant of the power factor correction. Power factors of almost 1 can be reached when using an active PFC. Practically no reactive power is drawn from the mains supply network; therefore the strain on the mains network is relatively low.</p>
Pollution severity	<p>Pollution severity describes the environment and ambient conditions that a device requires in order for it to function smoothly. Significant environmental variables include condensation or air containing dust and oil.</p>
Power-boost or boost	<p>The power-boost function is the surge current handling capacity in the seconds to minutes range. This function is often required for starting up DC motors. DC motors have a high start-up current and often require several seconds before they have achieved their rated rotational speed. The power-boost function helps to optimise this start-up phase.</p>
Power factor	<p>The power factor is the ratio of reactive power to apparent power. It is an indicator of the device performance with respect to the load on the mains power network. Depending on the technology in use, the power factor for power supplies can be between 0.45 and nearly 1.</p>

Power loss	For power supply units, the power loss specification indicates the thermal output emitted during nominal (rated) operations. This is a key specification used by engineers when designing the climate control systems within electrical cabinets. It is calculated as the difference between the input and output power and can also take the degree of efficiency into account.
Power rating	The continual output permitted under the rated conditions.
Power supply units connected in series	Power supplies can only be connected in series when this is clearly permitted by the manufacturer. Such series connections are then normally tied to certain conditions. They can be used to increase the output voltage. This is not widely implemented.
Protection degree	According to DIN EN 60529, devices can be classified according to their protection degrees. The numeric code (for example, IP 20) defines two protection degrees: protection against touch or penetration by external objects (the first digit) and protection against water penetration (the second digit). Switched-mode power supplies intended for use in electrical cabinets or similar enclosures are often designed with IP 20 protection. The first digit (in this case, 2) ensures finger protection. The second digit (0) indicates that no protection against water is provided.
Pulsed current capacity	The pulsed current capacity describes the dynamic performance of a switched-mode power supply. Capacitive consumer loads, with their high inrush currents, put a particular strain on a switched-mode power supply. Peak values are reached (in the ms range) which amount to levels many times higher than the mains current. If the current control mechanism reacts too quickly, this can lead to voltage drops and can cause problems for loads which are connected in parallel. For this reason, power supplies are often equipped with a surge current limiting factor based on time. This allows a high current output for only a few ms which can be much higher than the rated current.

R

Rated control voltage	The nominal value of the sparkover voltage for the relay.
Rated input voltage	The input voltage required at which, under the normal mains voltage fluctuations, the output levels can be kept stable. It usually corresponds to the rated voltage for the electric utility's power grid.
Rated output current	The long-term current permitted under the rated conditions.
Rated output voltage	The nominal output voltage used for the rated specifications. It usually corresponds to the factory default output voltage.

W

Redundancy	A power supply system is considered redundant if it is constructed so that it has partial power supplies which are independent of each other and each of these can individually deliver the output load. When a fault occurs, therefore, it is still possible to continue to supply the connected rated load. In reality, at least two power supplies are connected in parallel using decoupling diodes. In this way, a short circuit in the output of one power supply will not lead to the failure of the entire power supply system. → Diode modules
Regulated power supply units	Switched-mode power supplies, as opposed to more common power supply units, have become established as the standard for the 10–1,000 W power range. They produce a stable output voltage with minimal residual ripple, even when influenced by fluctuations in the mains voltage, mains frequency or load. Their small size and weight is a result of their superior efficiency degree. The electronic control mechanism typically ensures a constant output voltage that varies $\pm 1\%$.
Residual ripple	The residual ripple describes the ratio of superimposed AC voltage to DC voltage on the output side of the power supplies. In addition to a percent specification, the superimposed ripple is often specified in mV_{SS} for switched-mode power supplies.
Resistance to shock	Resistance to shock refers to mechanical immunity against impacts in any direction. This is a key factor while the product is being transported.
Response time	The response time is the time that a power supply unit needs to compensate for a disturbance (for example, a load fluctuation).

S

Switching frequency	Switched-mode power supplies are normally operated with switching frequencies from 20 to 200 kHz. The HF or power transformer is switched on and off using transistors at this switching frequency. Small, compact units can be built with this method in comparison with the traditional 50/60 Hz transformers.
----------------------------	--

Switched-mode power supply units

The switching pulse can be either primary or secondary. Thus there are primary switched-mode and secondary switched-mode power supply units. Secondary switched-mode power supply units are no longer of much significance. The primary switched-mode power supplies are now the focus of attention. The pulse refers to the high-frequency on and off switching of the transformer or transmitter in order to transmit energy. The high frequency allows the use of extra small inductive and capacitive components, particularly for the transmitter. In comparison to transformer-based power supply units, the weight and volume required are much reduced.

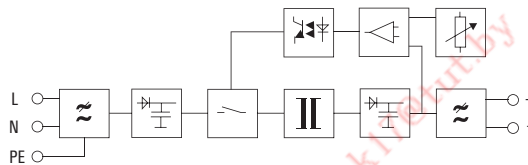
**Selectivity**

When surge protection equipment is connected in series, selectivity refers to the ability of only one upstream fuse to trigger selectively in the event of an overload. The differentiation can take into account current or also time. With DC power supply systems, selectivity refers to the separate fusing of load circuits on the DC side. In this case as well, only the proper series fuse should trigger in the event of an overload. Fuses in DC circuits play a critical role since the power supplies must react to upcoming short circuits with a speedy cut-off or by limiting the current. Usually electronic fuses are used for this purpose.

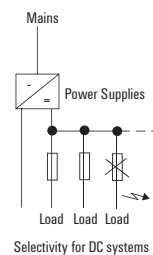
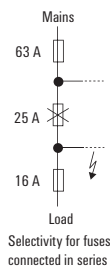
**SELV (safety extra low voltage)**

SELV refers to extra-low safety voltages according to IEC/EN 60950. Reinforced or doubled insulation between the primary and secondary sides is used to prevent electric shock. The output voltage here is sufficiently low so that it does not pose an injury risk if a person comes into direct contact. Earthing on the secondary side is possible but not required.

Surge

A surge is a high-power voltage pulse which can be caused by, for example, a lightning strike. The switching operations from large consumer loads can also generate such voltage surges on the mains network. The surge test is used to demonstrate the immunity against high-power voltage pulses.

T

Temperature range	The temperature range specifies the minimum and maximum ambient temperatures for which a device can start up and run continuously.
--------------------------	--

U

Unregulated power supply units	Unregulated power supplies consist mainly of a transformer, a rectifier and an Elkos filter. Since no controlling system is in place, mains voltage fluctuations influence the DC voltage side. Unregulated power supply units are very sturdy; they can be used in applications where a stabilised DC voltage is not necessary (for example, power supply to contactors).
---------------------------------------	--

V

Vibration resistance	Vibration resistance describes the resistance against constant mechanical vibrations that occur during operations. Rail and ship applications place stricter demands for vibration resistance on the device.
-----------------------------	--

W

Wide-range input	Modern switched-mode power supplies often feature a wide input range. They can be run under a wide range of voltages: from min. to max. rated voltages including the tolerance limits. They do not require any manual range switching.
-------------------------	--

г. Минск www.fotorele.net www.tiristor.by email minsk17@tut.by тел. +375447584780

W